

WEATHERTEX CONSTRUCTION DETAILS

WEATHERGROOVE PANELS

CAVITY & STEEL FRAME CONSTRUCTION

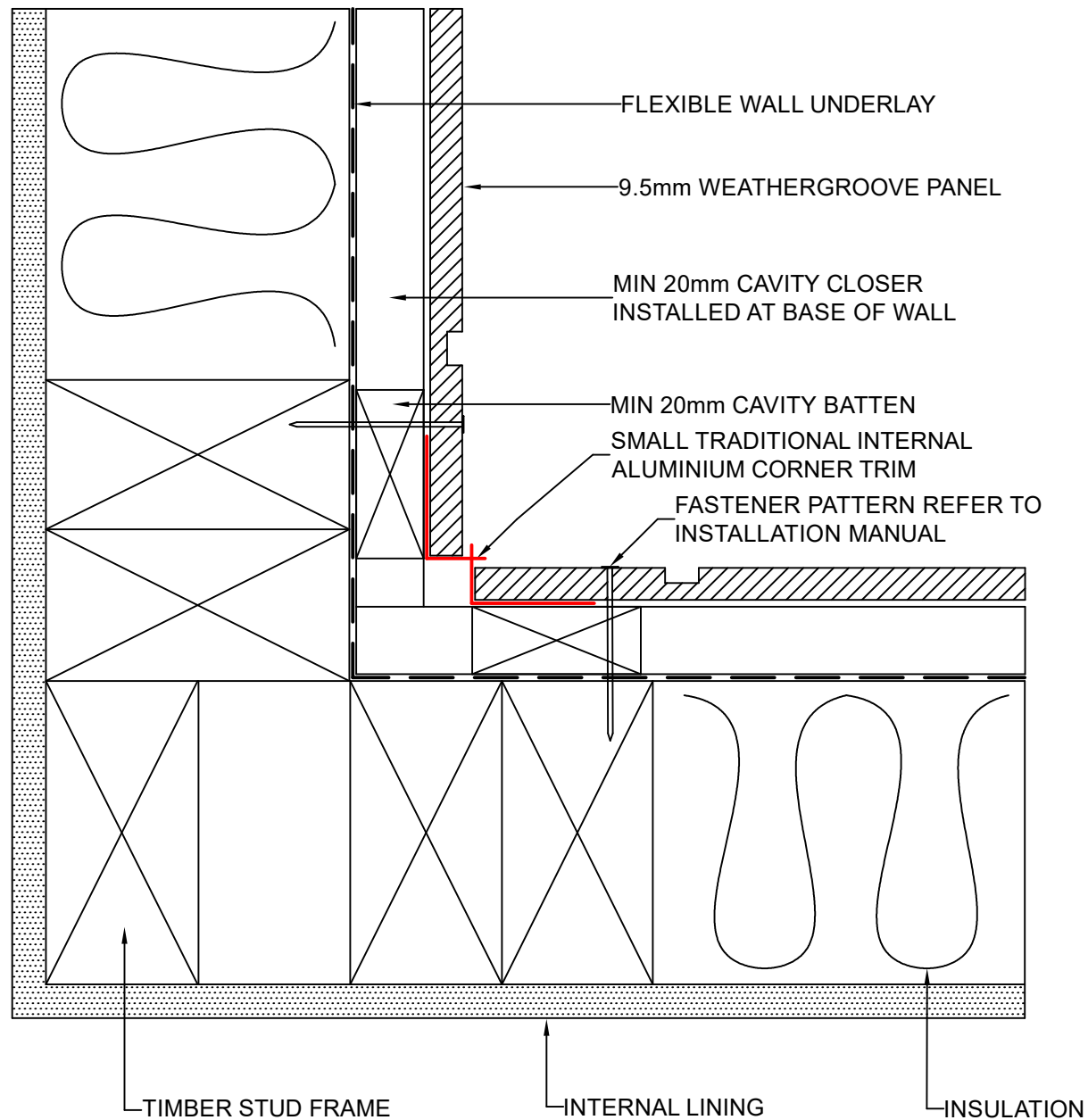

These drawings are for information only. They do not contain full details required for construction and must be used in conjunction with the current issue Weathertex Installation Manual, New Zealand Building Code and Local Regulations. Weathertex recommends gaining professional advice to ensure the drawings are suitable for your project. Weathertex accepts no liability in respect to the use of these drawings.



DRAWING NAME:
 CAVITY FIX INSTALLATION - SMALL INTERNAL CORNER
 (WEATHERGROOVE RANGE)

SCALE:
 NTS

DRAWN BY:
 A.MOATE

CHECKED BY:
 R.STUART

DATE:
 07.09.22

DRAWING No.:
 NZ-WG-CF-1

SHT SIZE
 A4

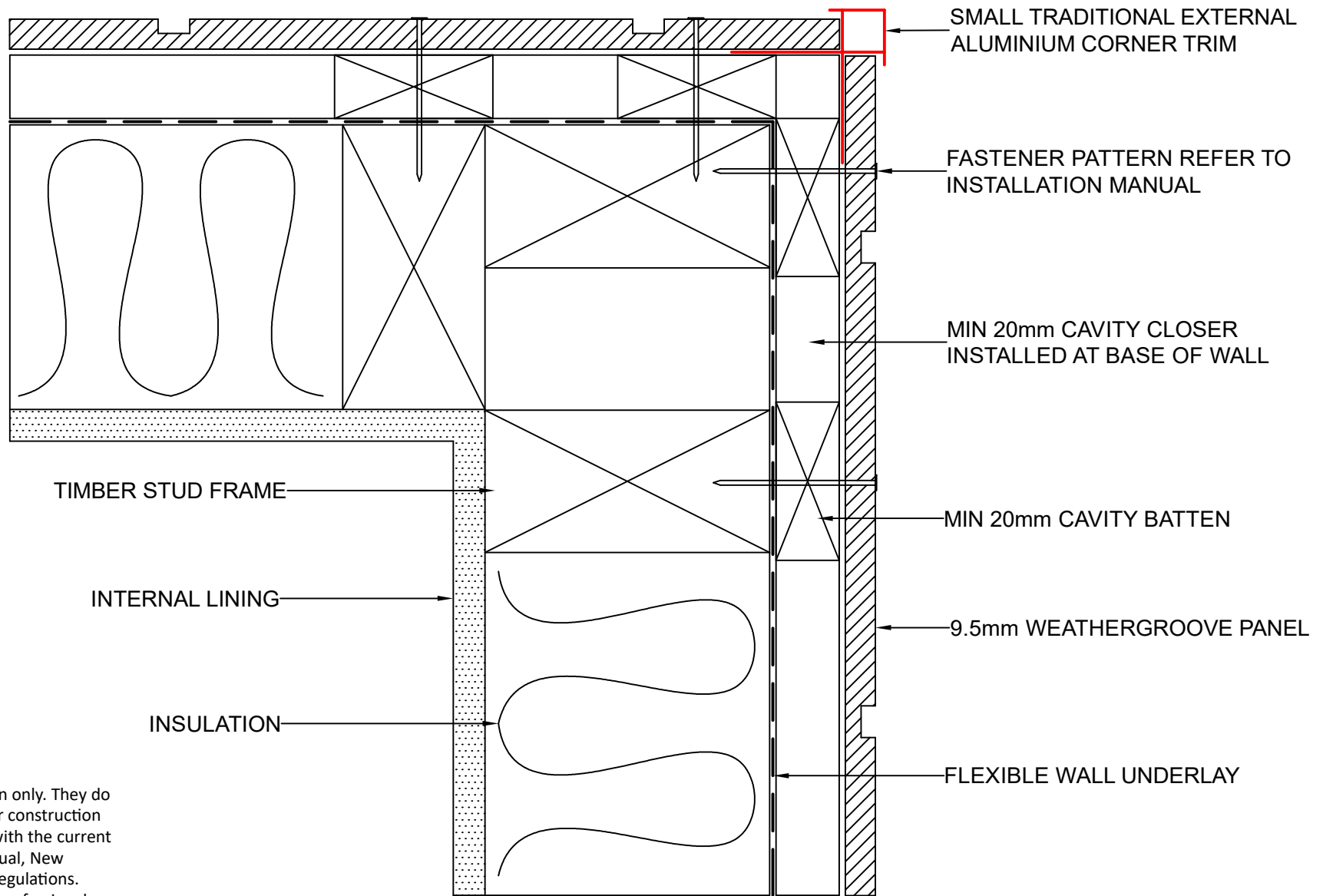

These drawings are for information only. They do not contain full details required for construction and must be used in conjunction with the current issue Weathertex Installation Manual, New Zealand Building Code and Local Regulations. Weathertex recommends gaining professional advice to ensure the drawings are suitable for your project. Weathertex accepts no liability in respect to the use of these drawings.



DRAWING NAME:
 CAVITY FIX INSTALLATION - SMALL EXTERNAL CORNER
 (WEATHERGROOVE RANGE)

SCALE:
 NTS

DRAWN BY:
 A.MOATE

CHECKED BY:
 R.STUART

DATE:
 07.09.22

DRAWING No.:
 NZ-WG-CF-2

SHT SIZE
 A4

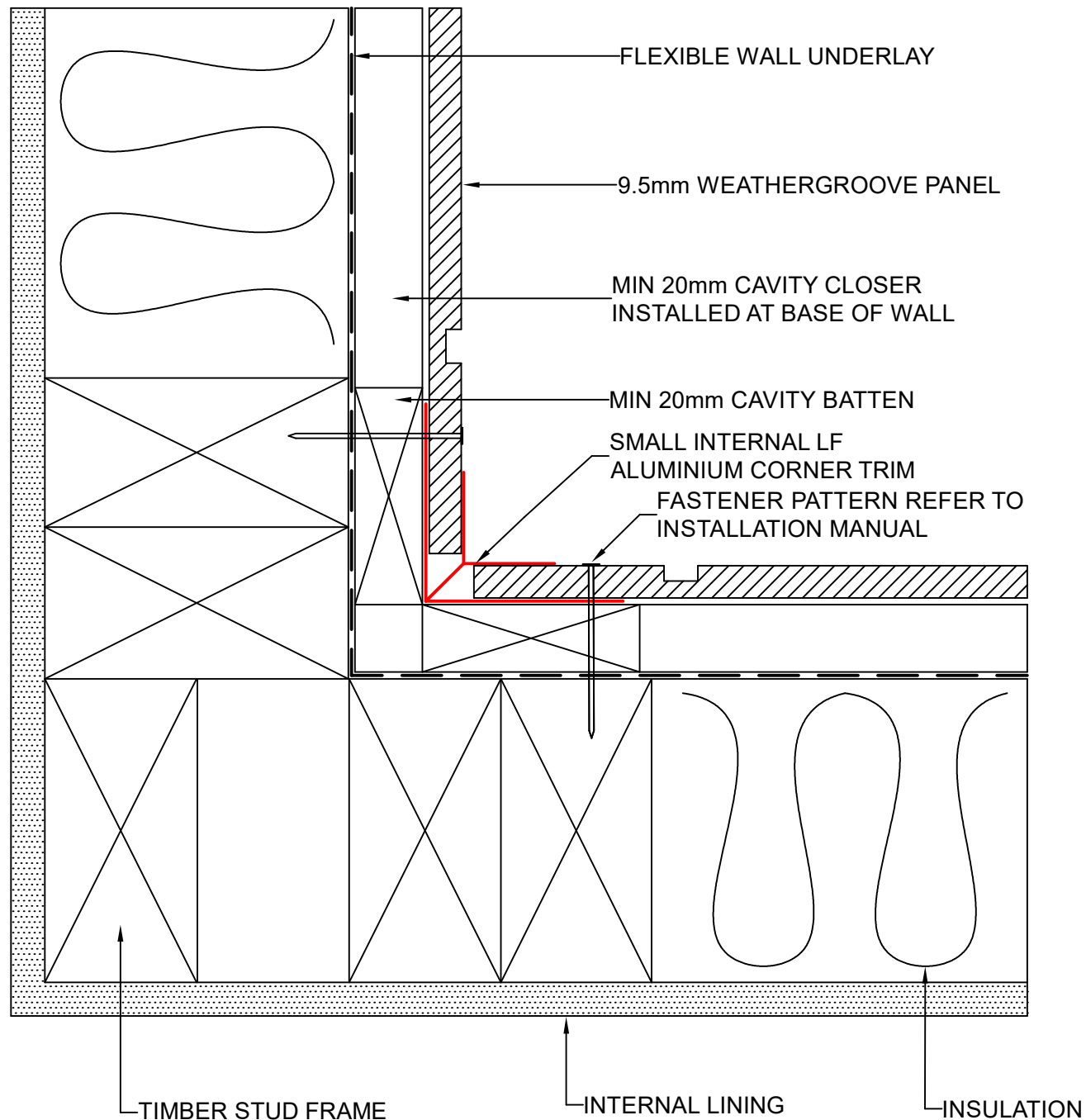

These drawings are for information only. They do not contain full details required for construction and must be used in conjunction with the current issue Weathertex Installation Manual, New Zealand Building Code and Local Regulations. Weathertex recommends gaining professional advice to ensure the drawings are suitable for your project. Weathertex accepts no liability in respect to the use of these drawings.



DRAWING NAME:
CAVITY FIX INSTALLATION - SMALL INTERNAL LF CORNER
(WEATHERGROOVE RANGE)

SCALE:
NTS

DRAWN BY:
A.MOATE

CHECKED BY:
R.STUART

DATE:
07.09.22

DRAWING No.:
NZ-WG-CF-3

SHT SIZE
A4

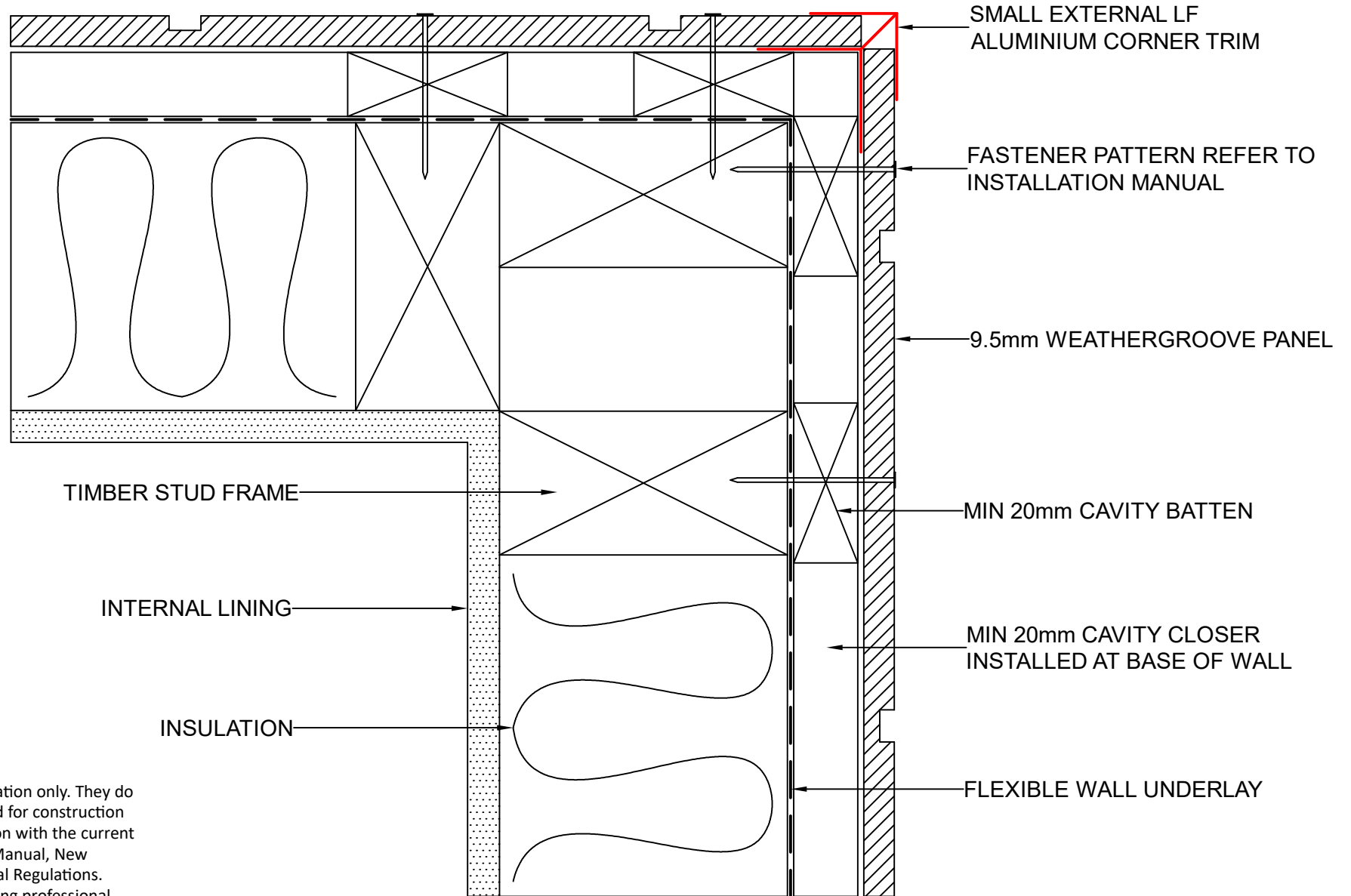

These drawings are for information only. They do not contain full details required for construction and must be used in conjunction with the current issue Weathertex Installation Manual, New Zealand Building Code and Local Regulations. Weathertex recommends gaining professional advice to ensure the drawings are suitable for your project. Weathertex accepts no liability in respect to the use of these drawings.



DRAWING NAME:
 CAVITY FIX INSTALLATION - SMALL EXTERNAL LF CORNER
 (WEATHERGROOVE RANGE)

SCALE:
 NTS

DRAWN BY:
 A.MOATE

CHECKED BY:
 R.STUART

DATE:
 07.09.22

DRAWING No.:
 NZ-WG-CF-4

SHT SIZE
 A4

These drawings are for information only. They do not contain full details required for construction and must be used in conjunction with the current issue Weathertex Installation Manual, New Zealand Building Code and Local Regulations. Weathertex recommends gaining professional advice to ensure the drawings are suitable for your project. Weathertex accepts no liability in respect to the use of these drawings.

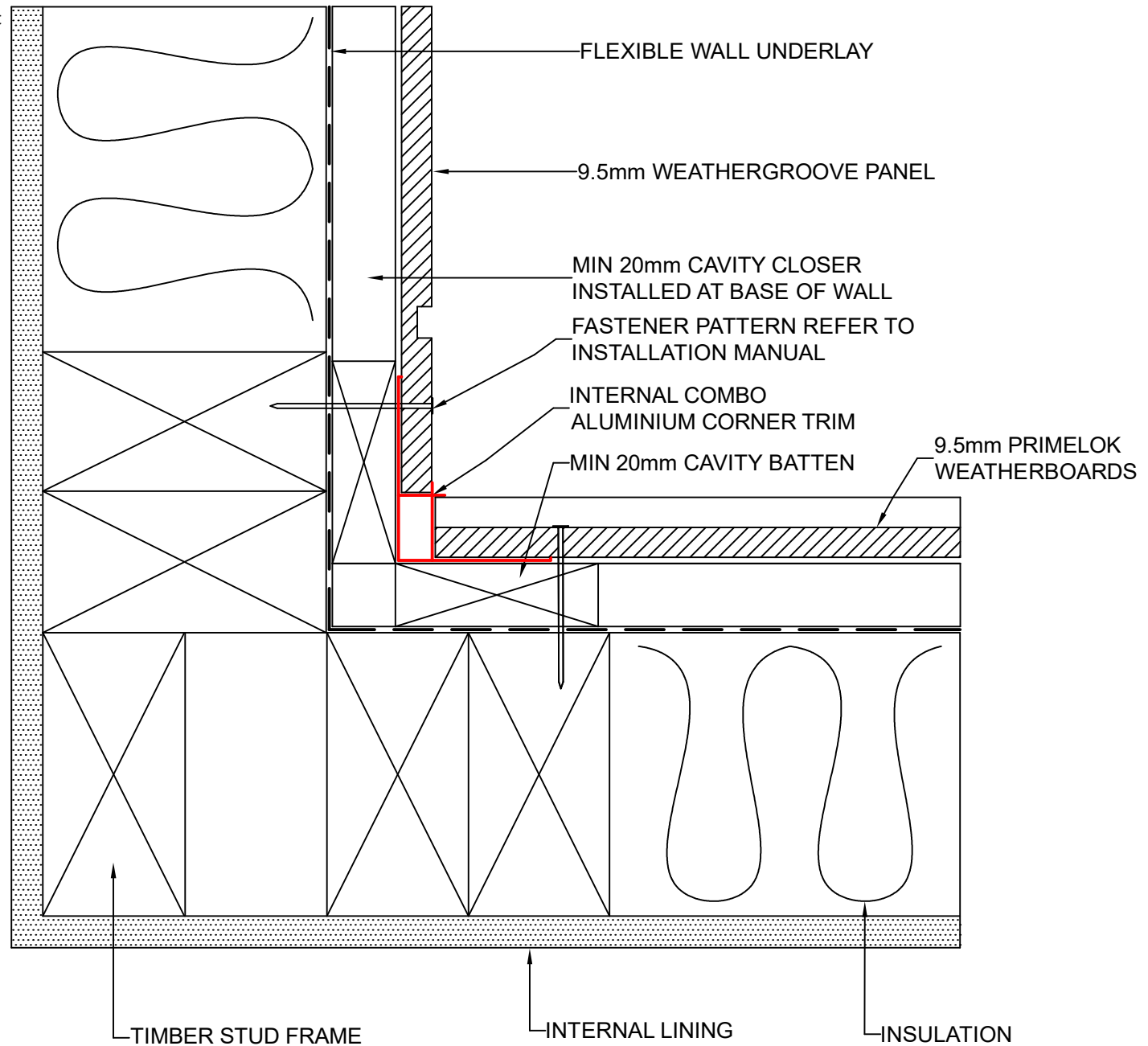

DRAWING NAME:
CAVITY FIX INSTALLATION - INTERNAL COMBO CORNER
(WEATHERGROOVE RANGE)

SCALE:
NTS

DRAWN BY:
A.MOATE

CHECKED BY:
R.STUART

DATE:
07.09.22

DRAWING No.:
NZ-WG-CF-5

SHT SIZE
A4

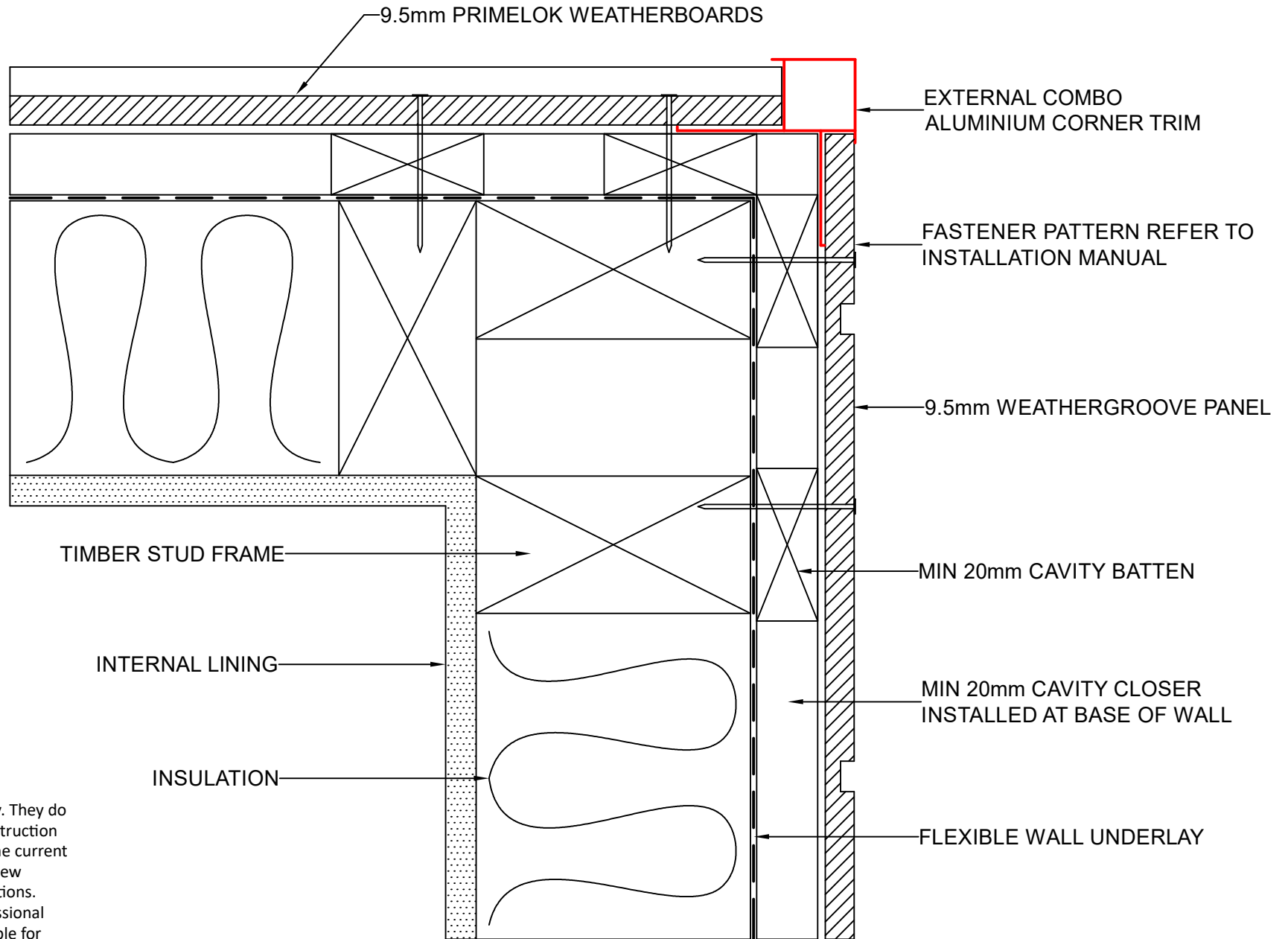

These drawings are for information only. They do not contain full details required for construction and must be used in conjunction with the current issue Weathertex Installation Manual, New Zealand Building Code and Local Regulations. Weathertex recommends gaining professional advice to ensure the drawings are suitable for your project. Weathertex accepts no liability in respect to the use of these drawings.



DRAWING NAME:
CAVITY FIX INSTALLATION - EXTERNAL COMBO CORNER
(WEATHERGROOVE RANGE)

SCALE:

NTS

DRAWN BY:

A.MOATE

CHECKED BY:

R.STUART

DATE:

07.09.22

DRAWING No.:

NZ-WG-CF-6

SHT SIZE

A4

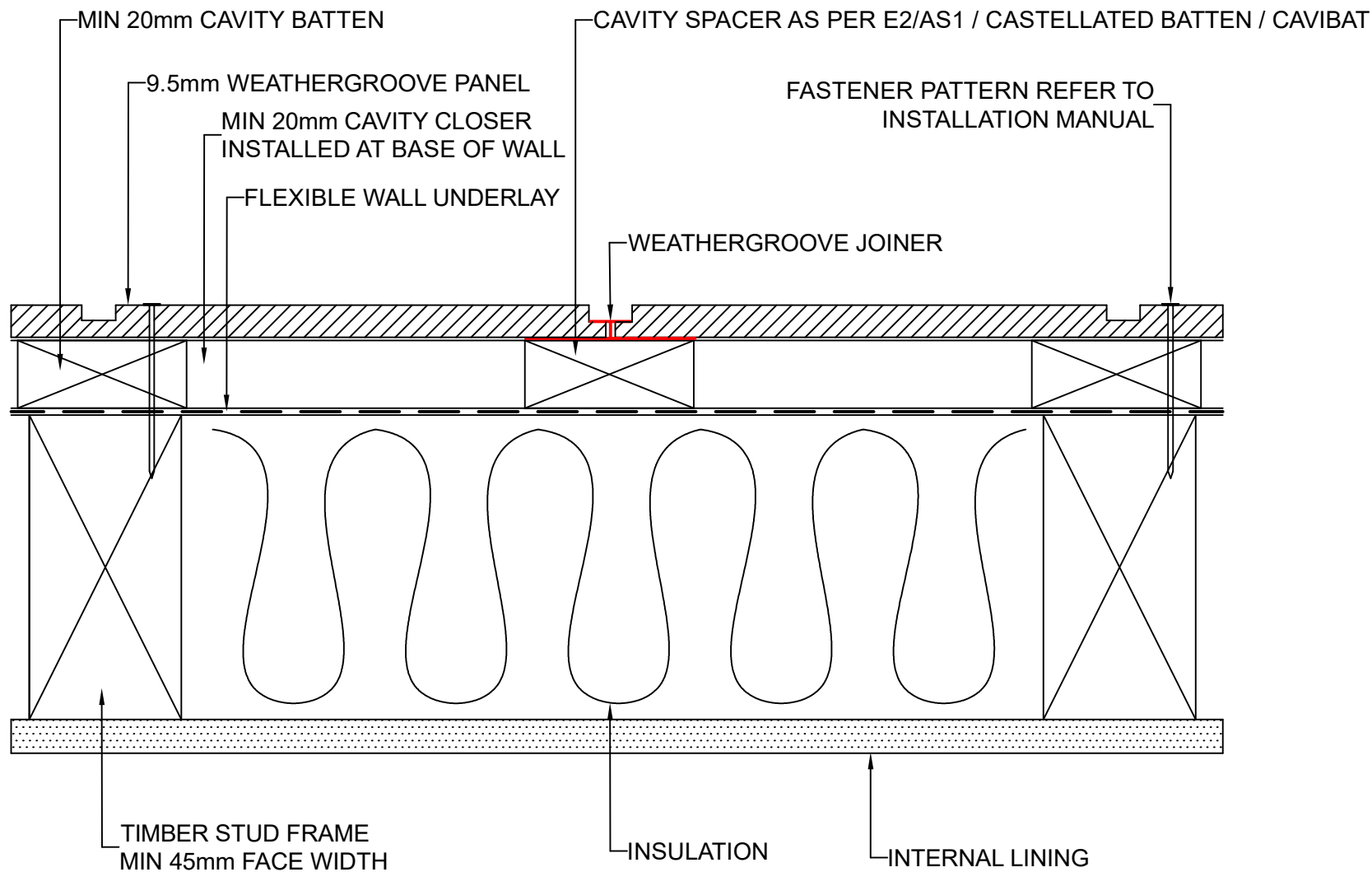

These drawings are for information only. They do not contain full details required for construction and must be used in conjunction with the current issue Weathertex Installation Manual, New Zealand Building Code and Local Regulations. Weathertex recommends gaining professional advice to ensure the drawings are suitable for your project. Weathertex accepts no liability in respect to the use of these drawings.



DRAWING NAME:
CAVITY FIX INSTALLATION - TRADITIONAL JOINING
(WEATHERGROOVE RANGE)

SCALE:
NTS

DRAWN BY:
A.MOATE

CHECKED BY:
R.STUART

DATE:
07.09.22

DRAWING No.:
NZ-WG-CF-7

SHT SIZE
A4

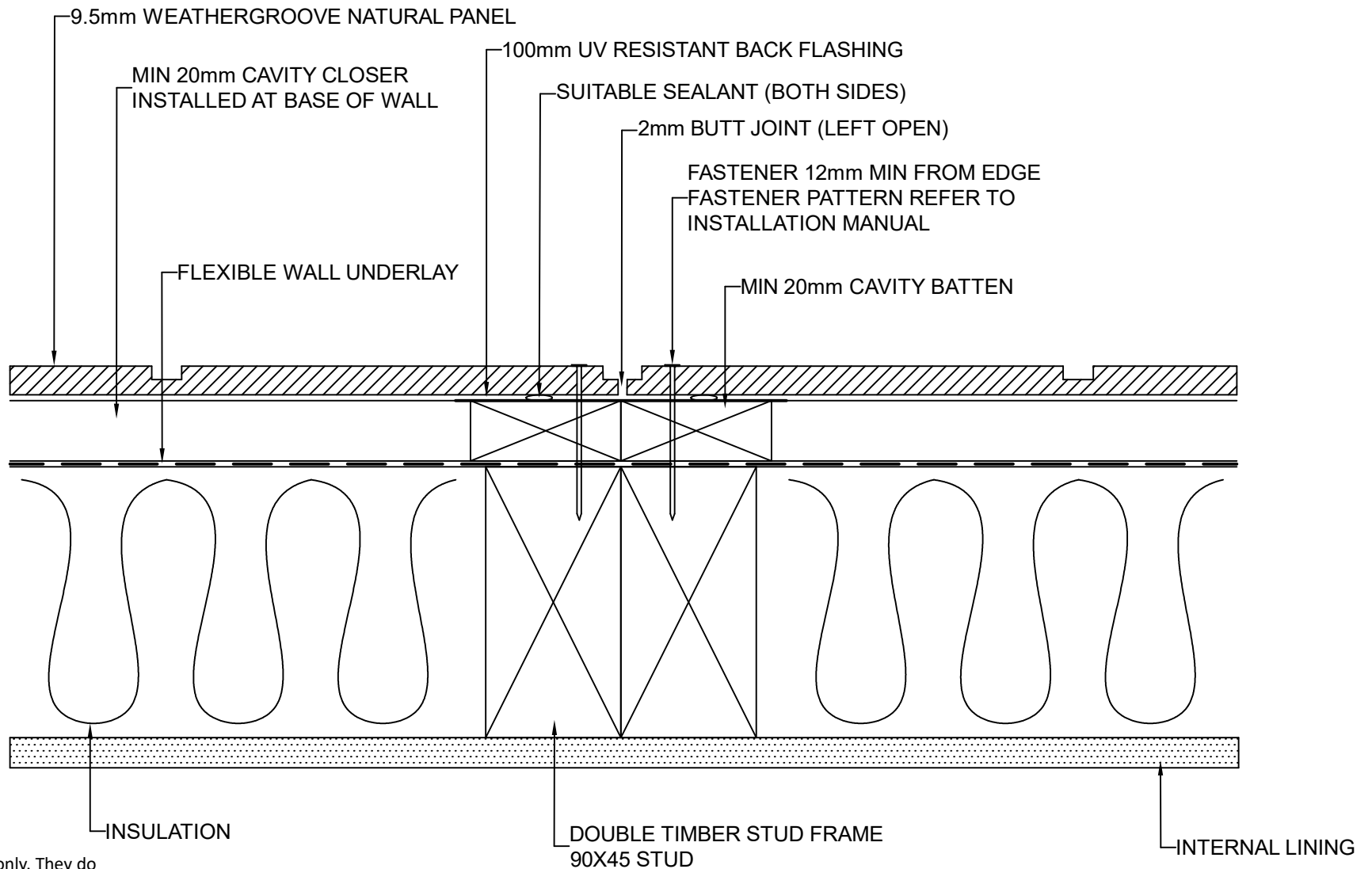

These drawings are for information only. They do not contain full details required for construction and must be used in conjunction with the current issue Weathertex Installation Manual, New Zealand Building Code and Local Regulations. Weathertex recommends gaining professional advice to ensure the drawings are suitable for your project. Weathertex accepts no liability in respect to the use of these drawings.



DRAWING NAME:
CAVITY FIX INSTALLATION - BUTT JOIN
(WEATHERGROOVE NATURAL RANGE)

SCALE:
NTS

DRAWN BY:
A.MOATE

CHECKED BY:
R.STUART

DATE:
07.09.22

DRAWING No.:
NZ-WG-CF-8

SHT SIZE
A4

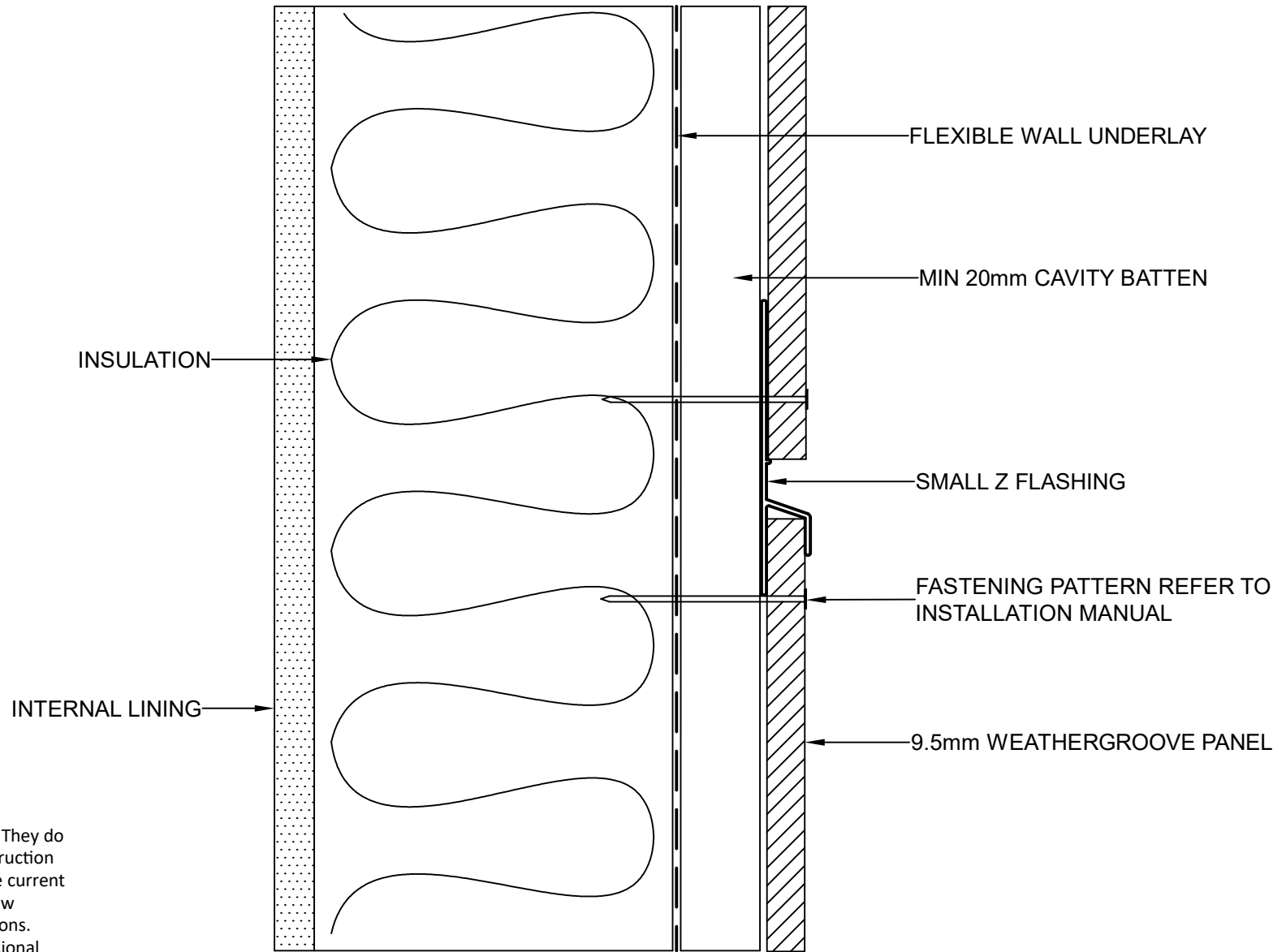

These drawings are for information only. They do not contain full details required for construction and must be used in conjunction with the current issue Weathertex Installation Manual, New Zealand Building Code and Local Regulations. Weathertex recommends gaining professional advice to ensure the drawings are suitable for your project. Weathertex accepts no liability in respect to the use of these drawings.



DRAWING NAME:
CAVITY FIX INSTALLATION - SMALL Z FLASHING
(WEATHERGROOVE RANGE)

SCALE:
NTS

DRAWN BY:
A.MOATE

CHECKED BY:
R.STUART

DATE:
07.09.22

DRAWING No.:
NZ-WG-CF-9

SHT SIZE
A4

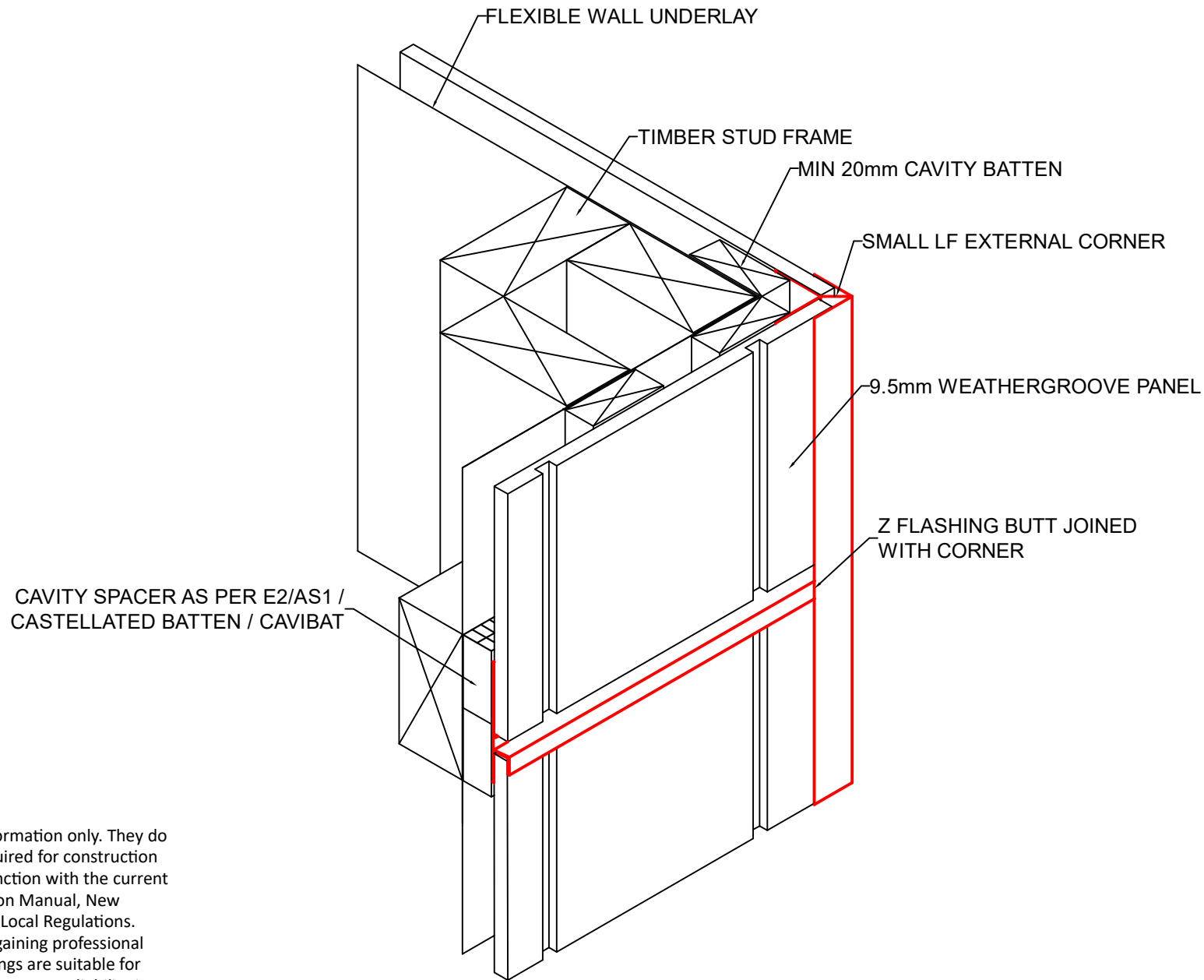

These drawings are for information only. They do not contain full details required for construction and must be used in conjunction with the current issue Weathertex Installation Manual, New Zealand Building Code and Local Regulations. Weathertex recommends gaining professional advice to ensure the drawings are suitable for your project. Weathertex accepts no liability in respect to the use of these drawings.



DRAWING NAME:
CAVITY FIX INSTALLATION - Z FLASHING INTO CORNER
(WEATHERGROOVE RANGE)

SCALE:
NTS

DRAWN BY:
A.MOATE

CHECKED BY:
R.STUART

DATE:
07.09.22

DRAWING No.:
NZ-WG-CF-10

SHT SIZE
A4

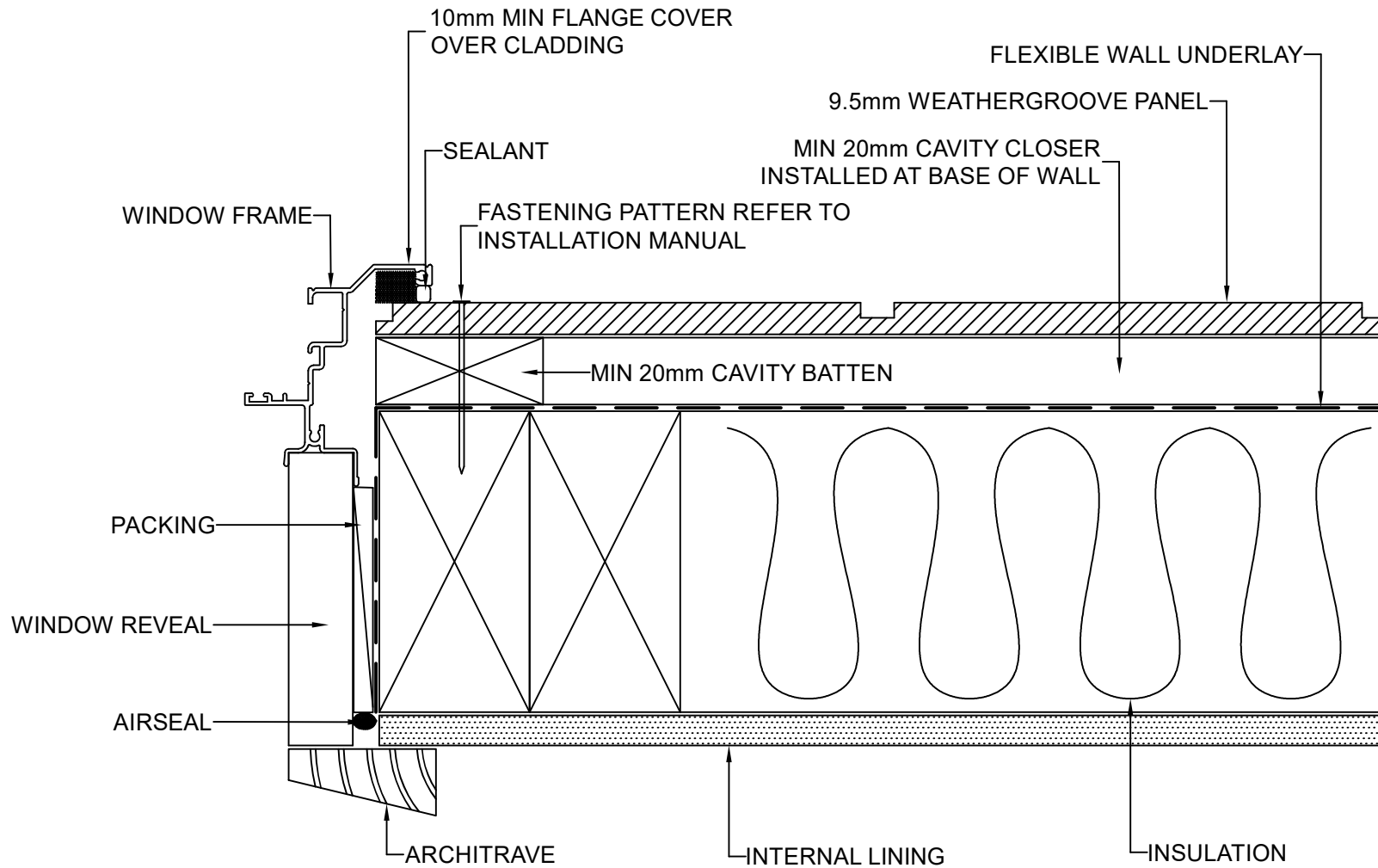

These drawings are for information only. They do not contain full details required for construction and must be used in conjunction with the current issue Weathertex Installation Manual, New Zealand Building Code and Local Regulations. Weathertex recommends gaining professional advice to ensure the drawings are suitable for your project. Weathertex accepts no liability in respect to the use of these drawings.



DRAWING NAME:
CAVITY FIX INSTALLATION - WINDOW JAMB
(WEATHERGROOVE RANGE)

SCALE:
NTS

DRAWN BY:
A.MOATE

CHECKED BY:
R.STUART

DATE:
07.09.22

DRAWING No.:
NZ-WG-CF-11

SHT SIZE
A4

These drawings are for information only. They do not contain full details required for construction and must be used in conjunction with the current issue Weathertex Installation Manual, New Zealand Building Code and Local Regulations. Weathertex recommends gaining professional advice to ensure the drawings are suitable for your project. Weathertex accepts no liability in respect to the use of these drawings.

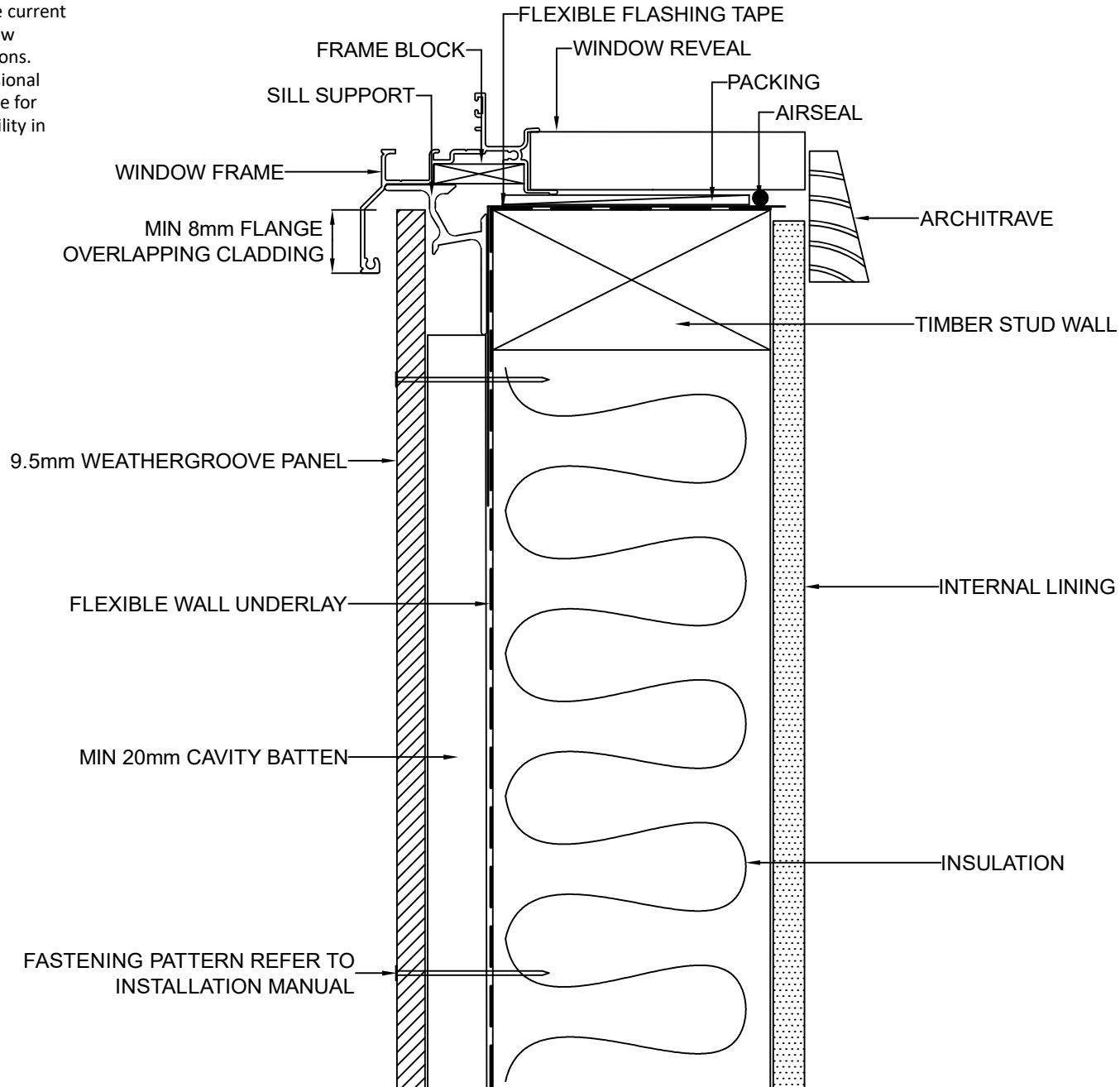

	DRAWING NAME: CAVITY FIX INSTALLATION - WINDOW SILL (WEATHERGROOVE RANGE)	SCALE:	DRAWN BY:	CHECKED BY:	DATE:	DRAWING No.:	SHT SIZE
		NTS	A.MOATE	R.STUART	07.09.22	NZ-WG-CF-12	A4

These drawings are for information only. They do not contain full details required for construction and must be used in conjunction with the current issue Weathertex Installation Manual, New Zealand Building Code and Local Regulations. Weathertex recommends gaining professional advice to ensure the drawings are suitable for your project. Weathertex accepts no liability in respect to the use of these drawings.

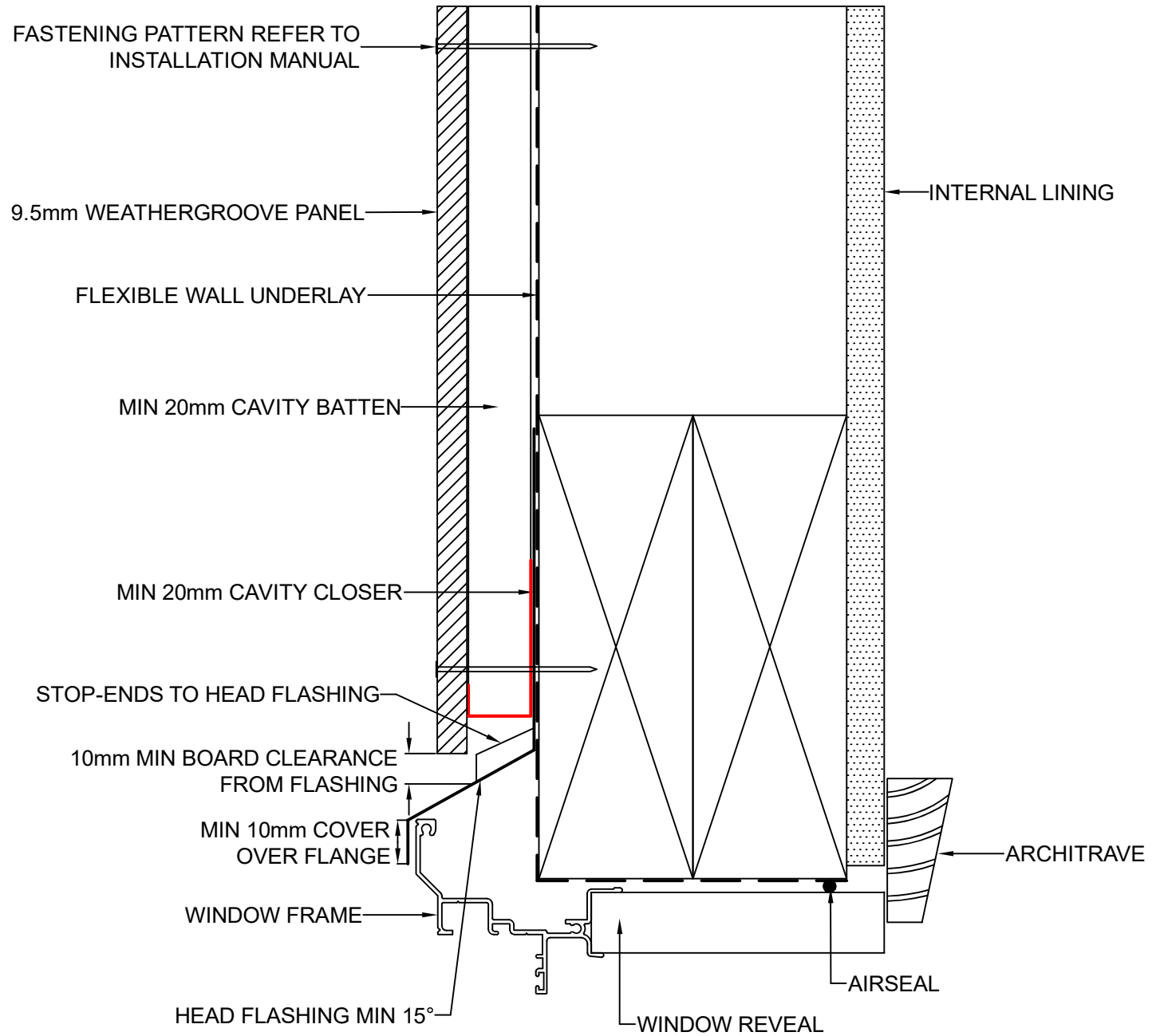

NOTE:

1. IN WIND AREAS OF VERY HIGH AND ABOVE, SEALANT MUST BE INSTALLED BETWEEN UNDERSIDE OF THE HEAD FLASHING AND TOP OF THE WINDOW HEAD FLANGE
2. EXTEND HEAD FLASHING MIN 20mm BEYOND WINDOW FRAME



DRAWING NAME:
CAVITY FIX INSTALLATION - WINDOW LINTEL
(WEATHERGROOVE RANGE)

SCALE:
NTS

DRAWN BY:
A.MOATE

CHECKED BY:
R.STUART

DATE:
07.09.22

DRAWING No.:
NZ-WG-CF-13

SHT SIZE
A4

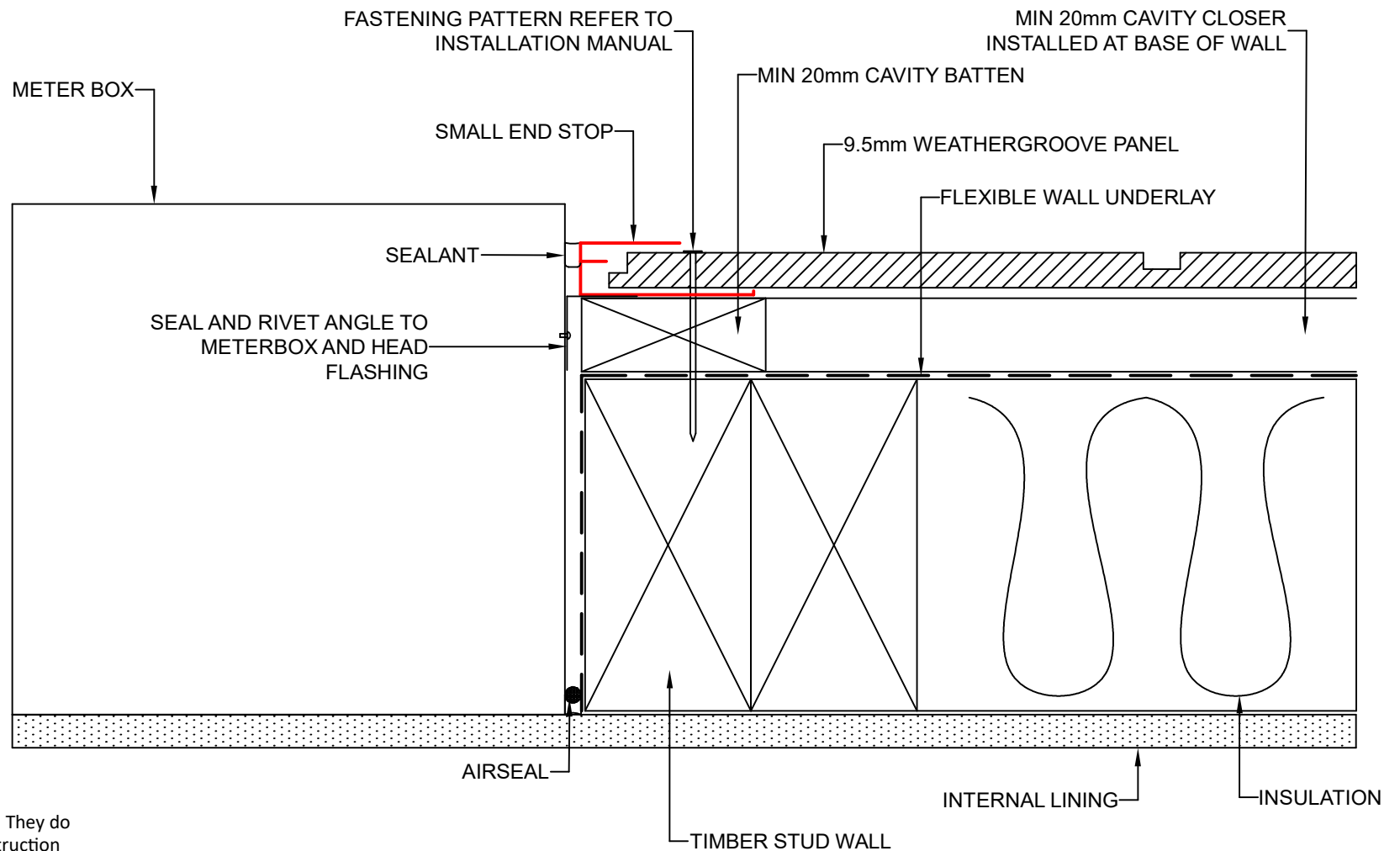

These drawings are for information only. They do not contain full details required for construction and must be used in conjunction with the current issue Weathertex Installation Manual, New Zealand Building Code and Local Regulations. Weathertex recommends gaining professional advice to ensure the drawings are suitable for your project. Weathertex accepts no liability in respect to the use of these drawings.

	DRAWING NAME: CAVITY FIX INSTALLATION - METER BOX JAMB (WEATHERGROOVE RANGE)	SCALE: NTS	DRAWN BY: A.MOATE	CHECKED BY: R.STUART	DATE: 07.09.22	DRAWING No.: NZ-WG-CF-14	SHT SIZE A4

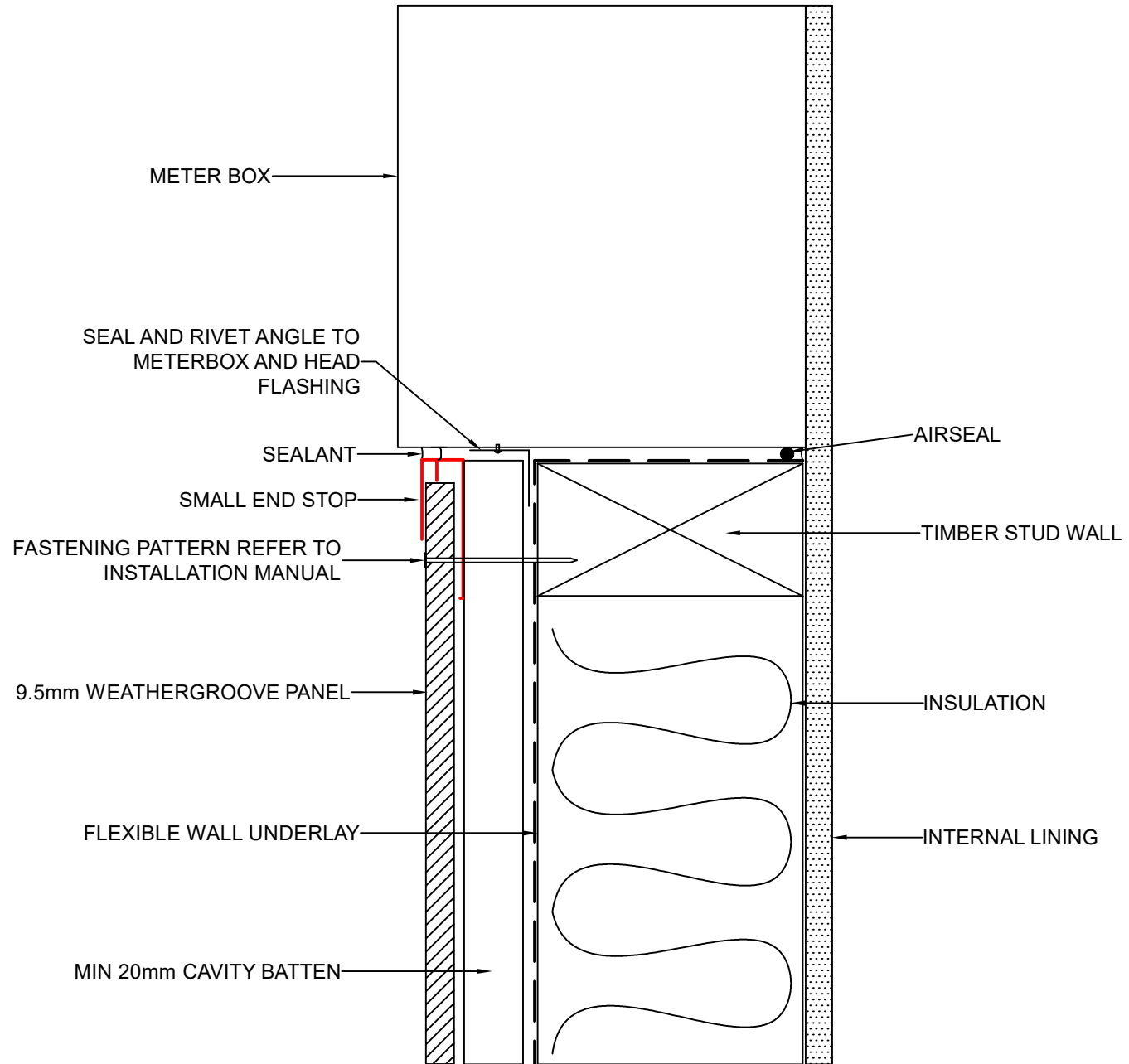

These drawings are for information only. They do not contain full details required for construction and must be used in conjunction with the current issue Weathertex Installation Manual, New Zealand Building Code and Local Regulations. Weathertex recommends gaining professional advice to ensure the drawings are suitable for your project. Weathertex accepts no liability in respect to the use of these drawings.



DRAWING NAME:
CAVITY FIX INSTALLATION - METER BOX SILL
(WEATHERGROOVE RANGE)

SCALE:
NTS

DRAWN BY:
A.MOATE

CHECKED BY:
R.STUART

DATE:
07.09.22

DRAWING No.:
NZ-WG-CF-15

SHT SIZE
A4

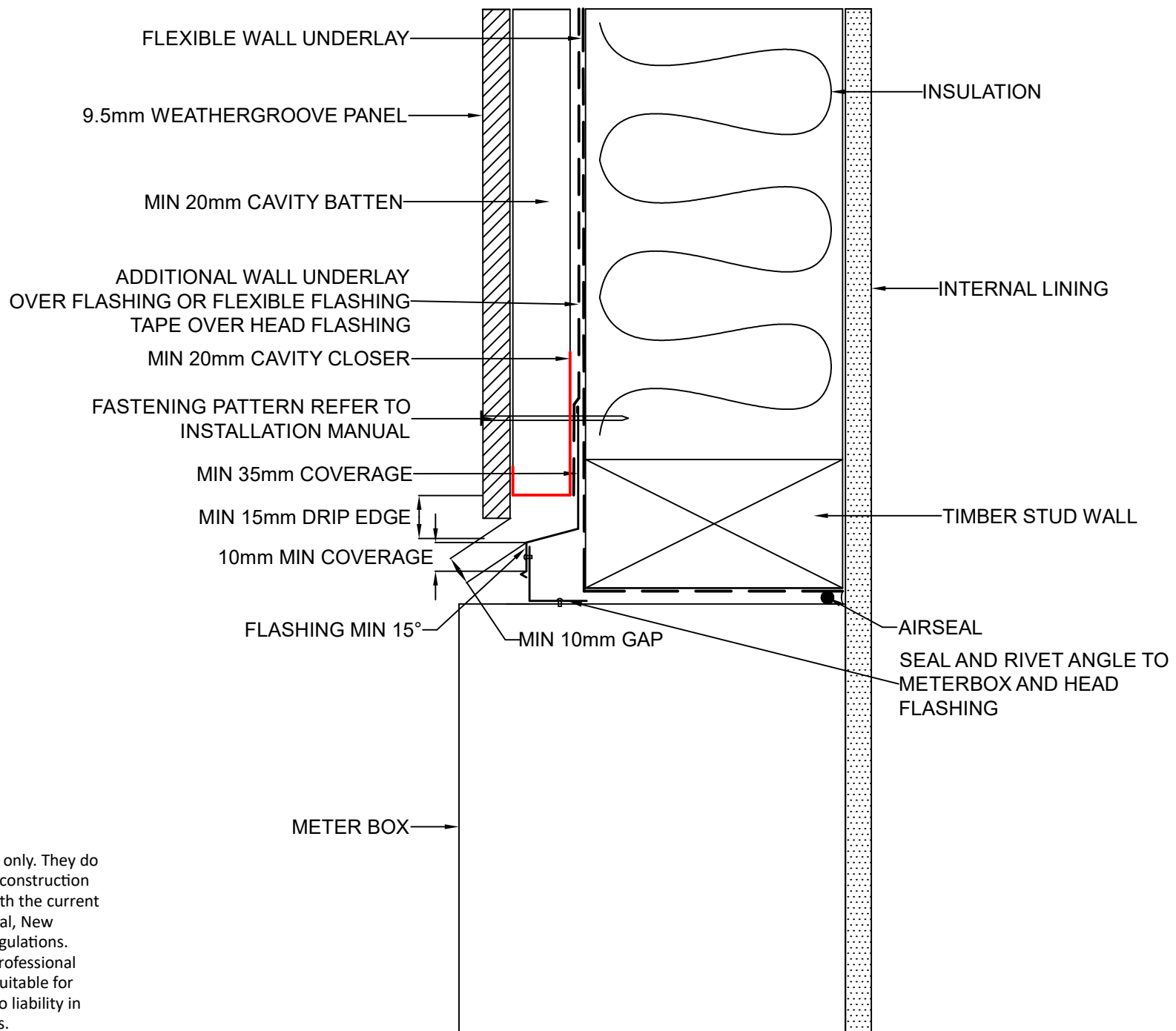

These drawings are for information only. They do not contain full details required for construction and must be used in conjunction with the current issue Weathertex Installation Manual, New Zealand Building Code and Local Regulations. Weathertex recommends gaining professional advice to ensure the drawings are suitable for your project. Weathertex accepts no liability in respect to the use of these drawings.



DRAWING NAME:
CAVITY FIX INSTALLATION - METER BOX HEAD
(WEATHERGROOVE RANGE)

SCALE:

NTS

DRAWN BY:

A.MOATE

CHECKED BY:

R.STUART

DATE:

07.09.22

DRAWING No.:

NZ-WG-CF-16

SHT SIZE

A4

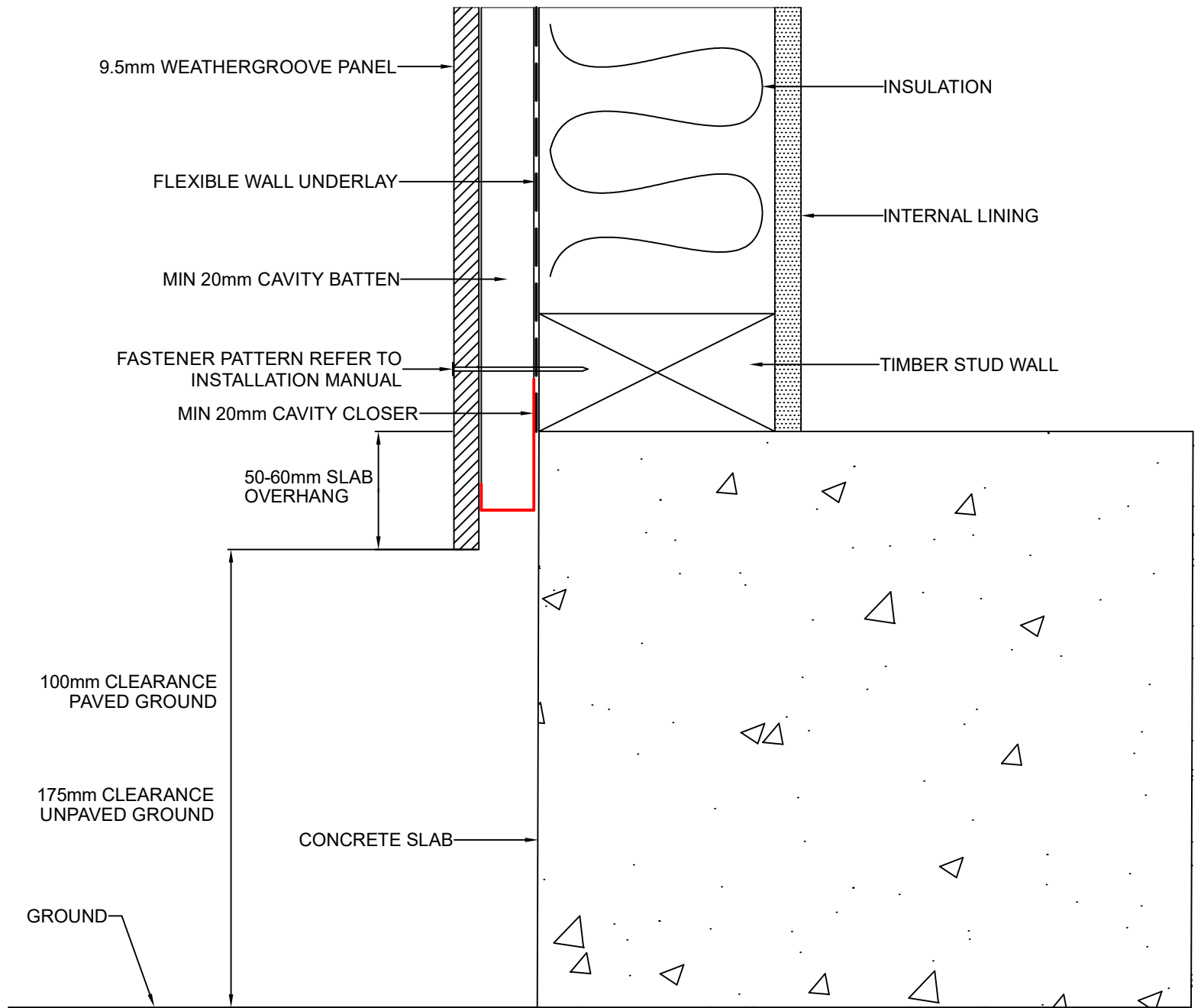

These drawings are for information only. They do not contain full details required for construction and must be used in conjunction with the current issue Weathertex Installation Manual, New Zealand Building Code and Local Regulations. Weathertex recommends gaining professional advice to ensure the drawings are suitable for your project. Weathertex accepts no liability in respect to the use of these drawings.



DRAWING NAME:
CAVITY FIX INSTALLATION - GROUND CLEARANCE
(WEATHERGROOVE RANGE)

SCALE:

NTS

DRAWN BY:

A.MOATE

CHECKED BY:

R.STUART

DATE:

07.09.22

DRAWING No.:

NZ-WG-CF-17

SHT SIZE

A4

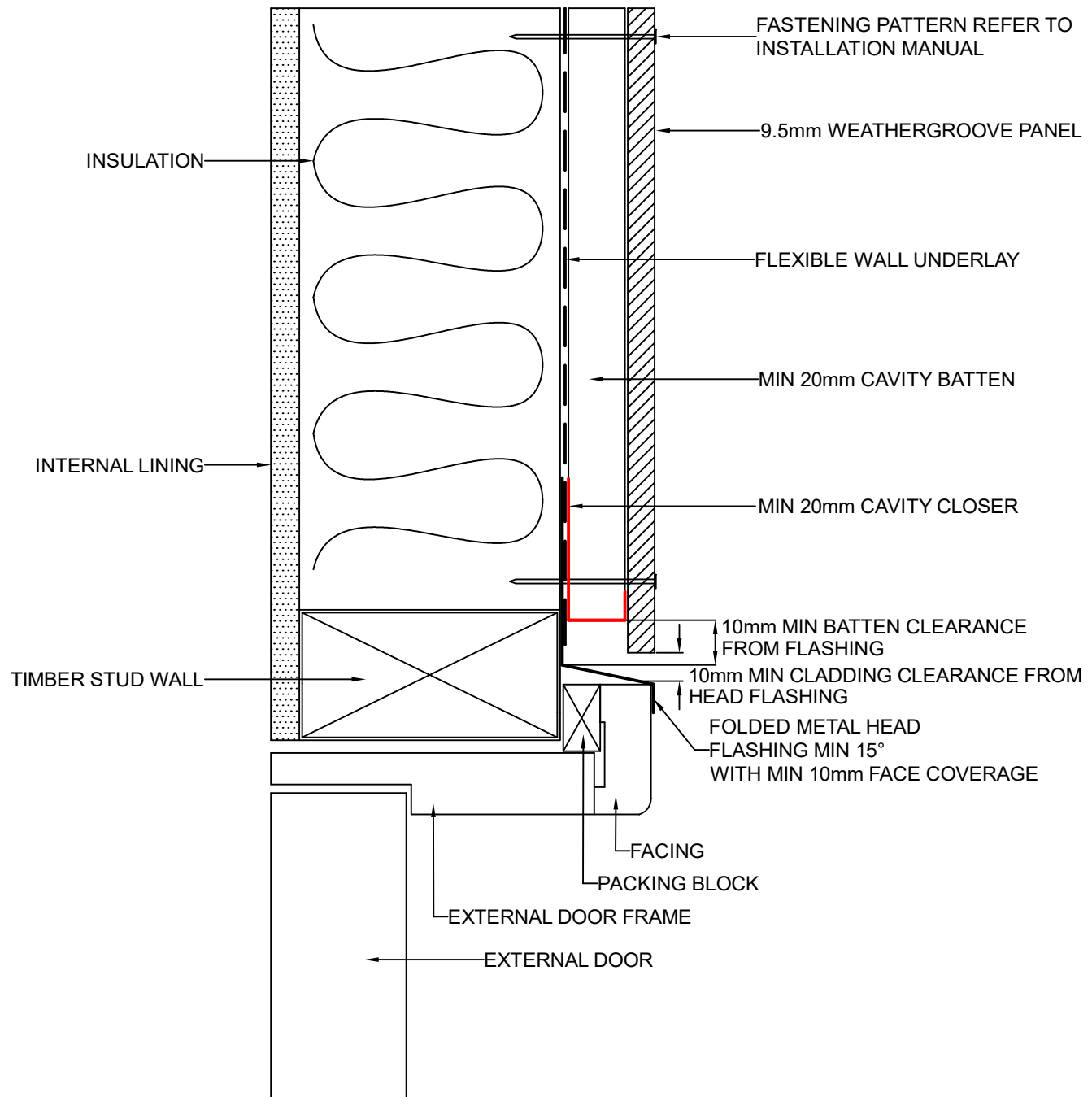

These drawings are for information only. They do not contain full details required for construction and must be used in conjunction with the current issue Weathertex Installation Manual, New Zealand Building Code and Local Regulations. Weathertex recommends gaining professional advice to ensure the drawings are suitable for your project. Weathertex accepts no liability in respect to the use of these drawings.



DRAWING NAME:
CAVITY FIX INSTALLATION - DOOR HEAD
(WEATHERGROOVE RANGE)

SCALE:
NTS

DRAWN BY:
A.MOATE

CHECKED BY:
R.STUART

DATE:
07.09.22

DRAWING No.:
NZ-WG-CF-18

SHT SIZE
A4

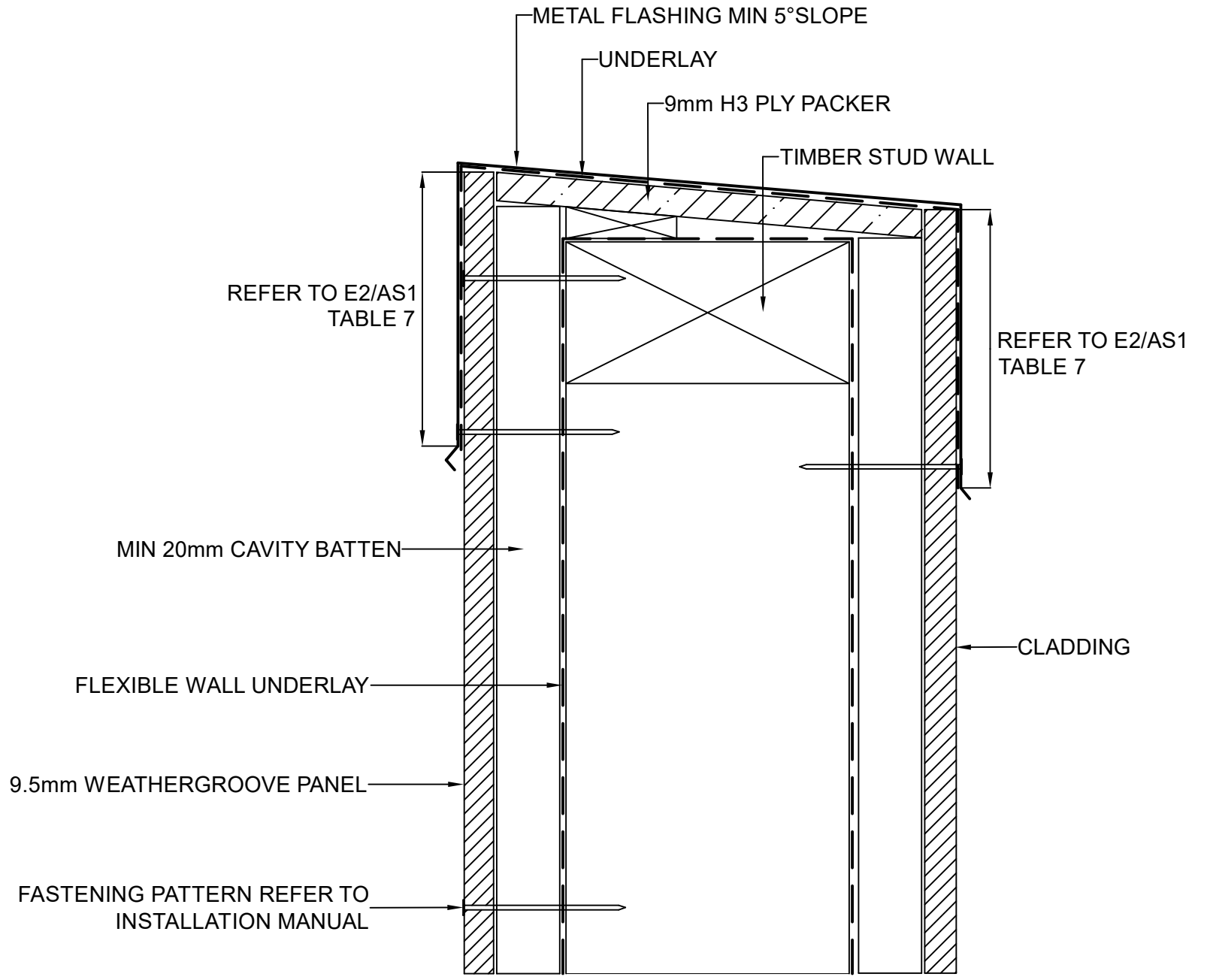

REFER TO E2/AS1
TABLE 7

REFER TO E2/AS1
TABLE 7

MIN 20mm CAVITY BATTEN

CLADDING

FLEXIBLE WALL UNDERLAY

9.5mm WEATHERGROOVE PANEL

FASTENING PATTERN REFER TO
INSTALLATION MANUAL

FOR BALUSTRADE/WALL JUNCTION
REFER TO E2/AS1 FIG. 11 & 12

These drawings are for information only. They do not contain full details required for construction and must be used in conjunction with the current issue Weathertex Installation Manual, New Zealand Building Code and Local Regulations. Weathertex recommends gaining professional advice to ensure the drawings are suitable for your project. Weathertex accepts no liability in respect to the use of these drawings.

	DRAWING NAME: CAVITY FIX INSTALLATION - PARAPET (WEATHERGROOVE RANGE)	SCALE: NTS	DRAWN BY: A.MOATE	CHECKED BY: R.STUART	DATE: 07.09.22	DRAWING No.: NZ-WG-CF-19	SHT SIZE A4

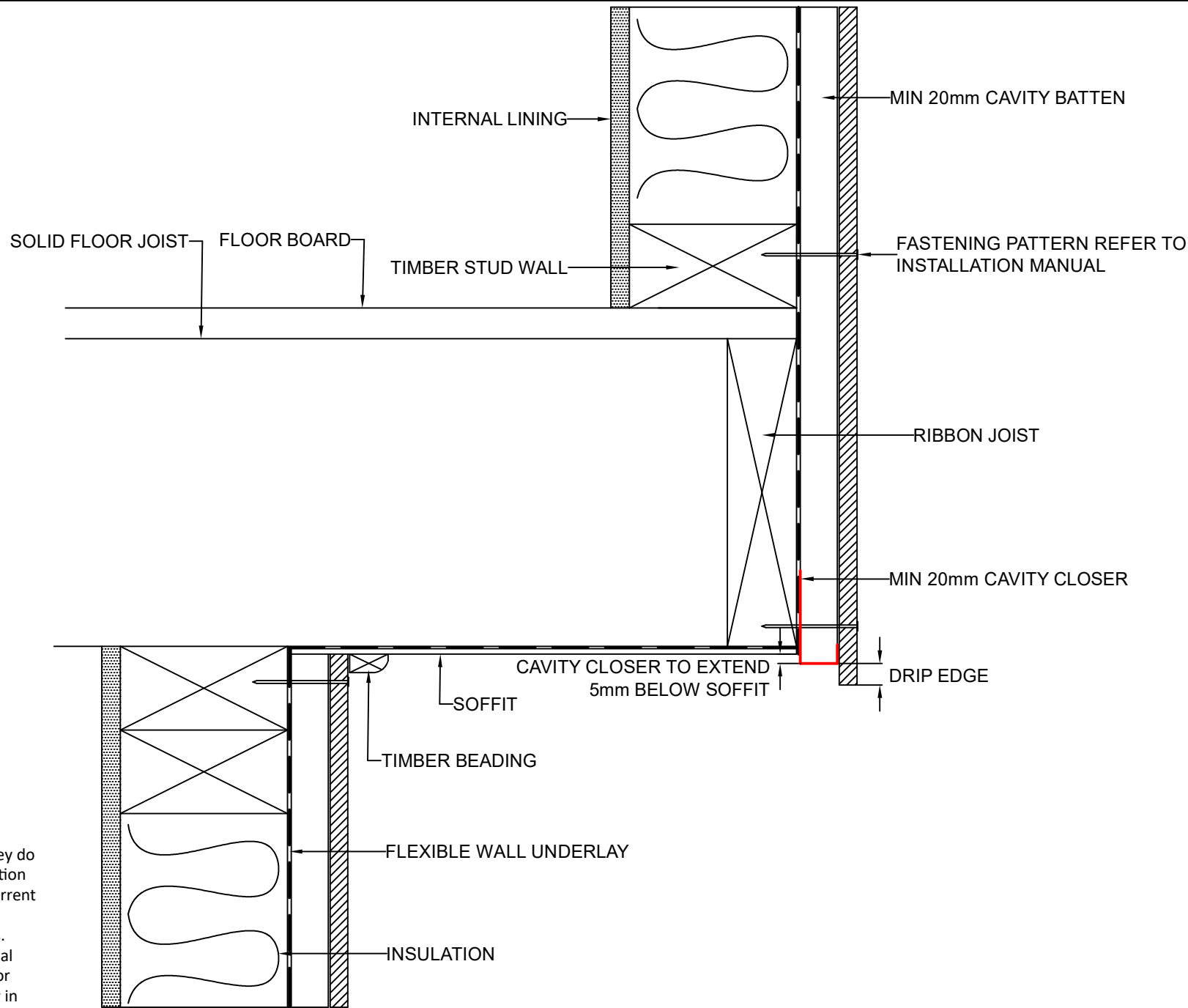

These drawings are for information only. They do not contain full details required for construction and must be used in conjunction with the current issue Weathertex Installation Manual, New Zealand Building Code and Local Regulations. Weathertex recommends gaining professional advice to ensure the drawings are suitable for your project. Weathertex accepts no liability in respect to the use of these drawings.



DRAWING NAME:
CAVITY FIX INSTALLATION - CANTILEVER ROOF
(WEATHERGROOVE RANGE)

SCALE:
NTS

DRAWN BY:
A.MOATE

CHECKED BY:
R.STUART

DATE:
07.09.22

DRAWING No.:
NZ-WG-CF-20

SHT SIZE
A4

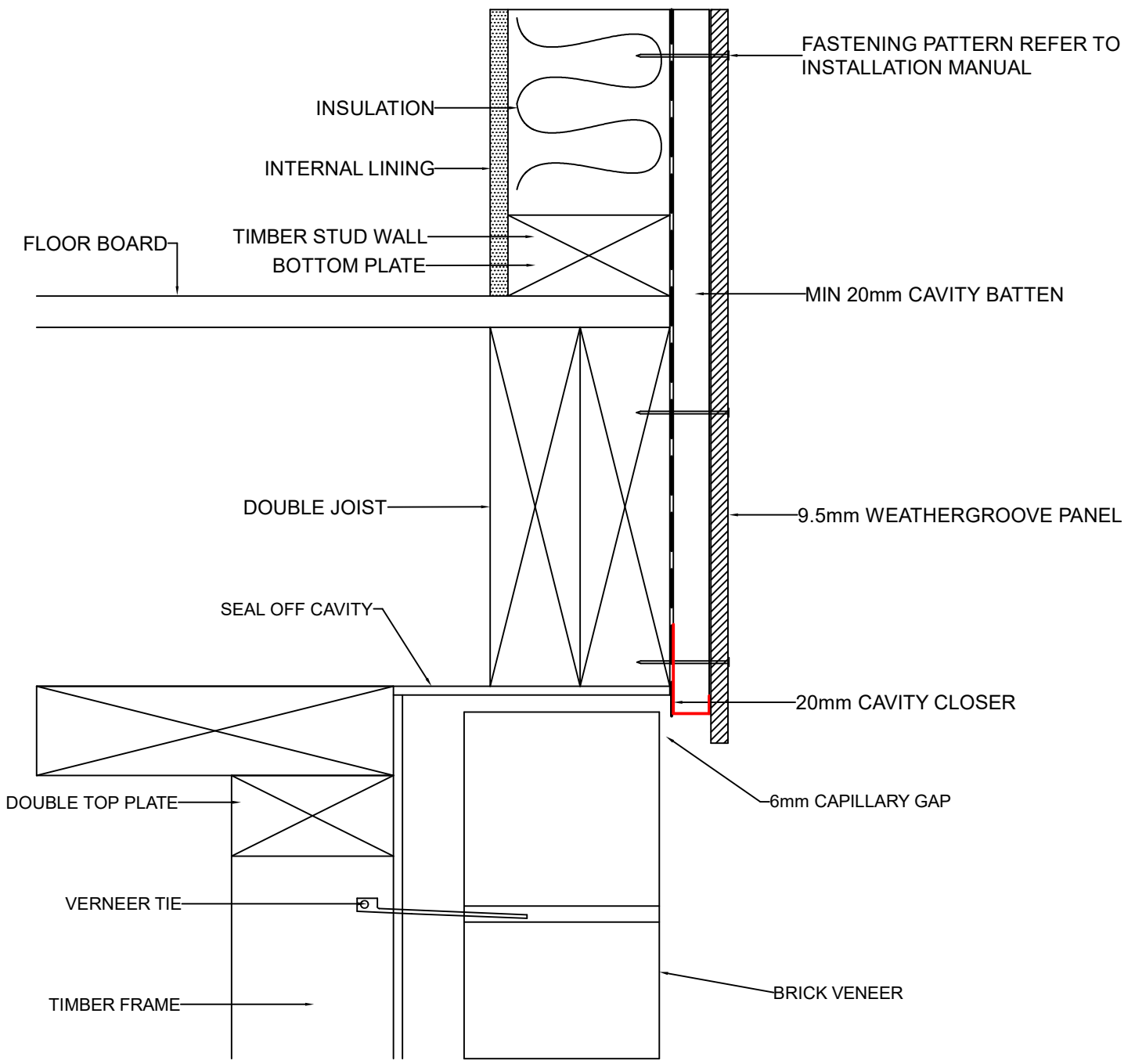

These drawings are for information only. They do not contain full details required for construction and must be used in conjunction with the current issue Weathertex Installation Manual, New Zealand Building Code and Local Regulations. Weathertex recommends gaining professional advice to ensure the drawings are suitable for your project. Weathertex accepts no liability in respect to the use of these drawings.

	DRAWING NAME:	SCALE:	DRAWN BY:	CHECKED BY:	DATE:	DRAWING No.:	SHT SIZE
	CAVITY FIX INSTALLATION - FLUSH WITH VENEER (WEATHERGROOVE RANGE)	NTS	A.MOATE	R.STUART	07.09.22	NZ-WG-CF-21	A4

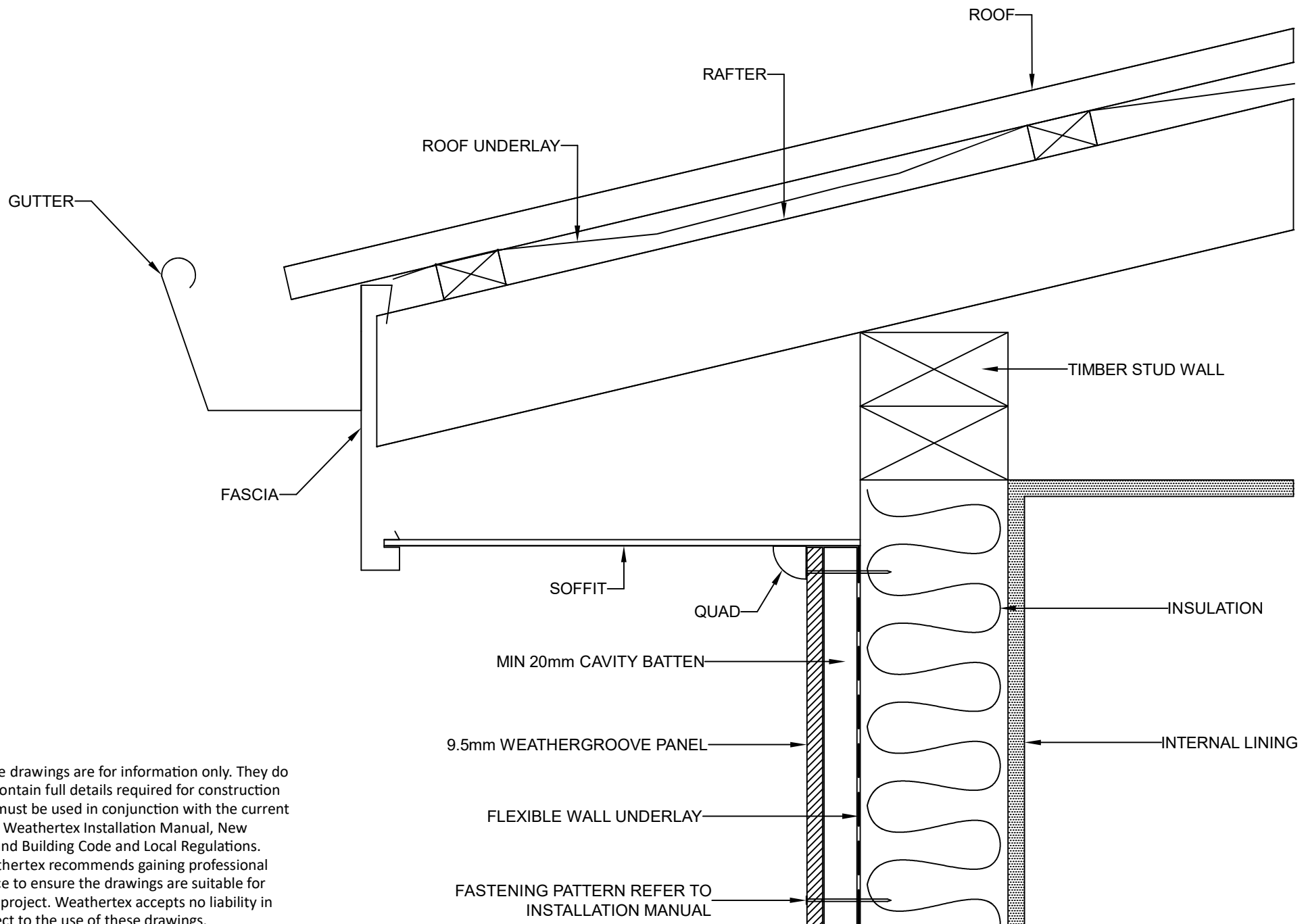

These drawings are for information only. They do not contain full details required for construction and must be used in conjunction with the current issue Weathertex Installation Manual, New Zealand Building Code and Local Regulations. Weathertex recommends gaining professional advice to ensure the drawings are suitable for your project. Weathertex accepts no liability in respect to the use of these drawings.



DRAWING NAME:
CAVITY FIX INSTALLATION - SOFFIT
(WEATHERGROOVE RANGE)

SCALE:
NTS

DRAWN BY:
A.MOATE

CHECKED BY:
R.STUART

DATE:
07.09.22

DRAWING No.:
NZ-WG-CF-22

SHT SIZE
A4

These drawings are for information only. They do not contain full details required for construction and must be used in conjunction with the current issue Weathertex Installation Manual, New Zealand Building Code and Local Regulations. Weathertex recommends gaining professional advice to ensure the drawings are suitable for your project. Weathertex accepts no liability in respect to the use of these drawings.

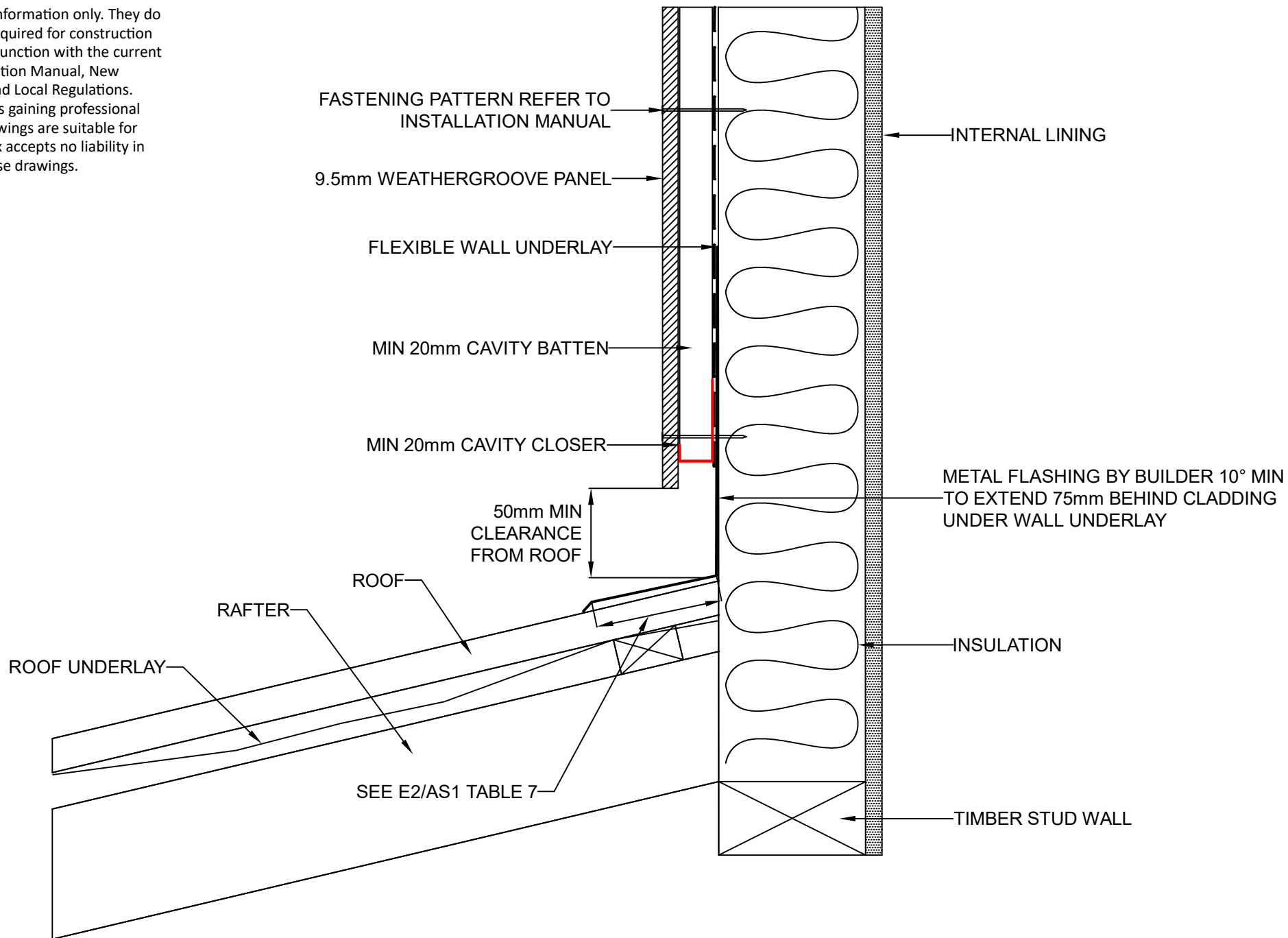

DRAWING NAME:
CAVITY FIX INSTALLATION - ROOF CLEARANCE
(WEATHERGROOVE RANGE)

SCALE:
NTS

DRAWN BY:
A.MOATE

CHECKED BY:
R.STUART

DATE:
07.09.22

DRAWING No.:
NZ-WG-CF-23

SHT SIZE
A4

These drawings are for information only. They do not contain full details required for construction and must be used in conjunction with the current issue Weathertex Installation Manual, New Zealand Building Code and Local Regulations. Weathertex recommends gaining professional advice to ensure the drawings are suitable for your project. Weathertex accepts no liability in respect to the use of these drawings.

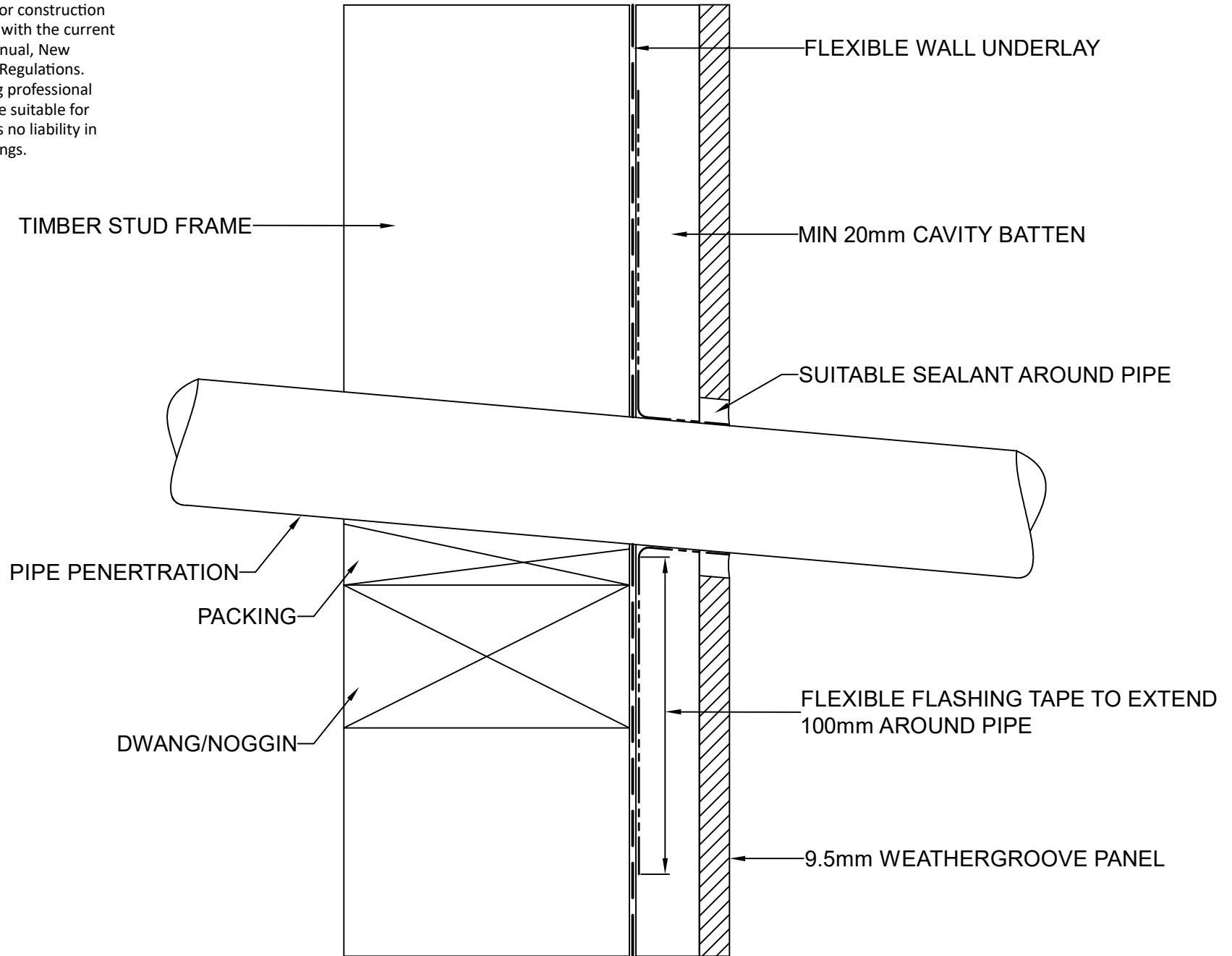

DRAWING NAME:
CAVITY FIX INSTALLATION - PIPE PENETRATION
(WEATHERGROOVE RANGE)

SCALE:
NTS

DRAWN BY:
A.MOATE

CHECKED BY:
R.STUART

DATE:
07.09.22

DRAWING No.:
NZ-WG-CF-24

SHT SIZE
A4

These drawings are for information only. They do not contain full details required for construction and must be used in conjunction with the current issue Weathertex Installation Manual, New Zealand Building Code and Local Regulations. Weathertex recommends gaining professional advice to ensure the drawings are suitable for your project. Weathertex accepts no liability in respect to the use of these drawings.

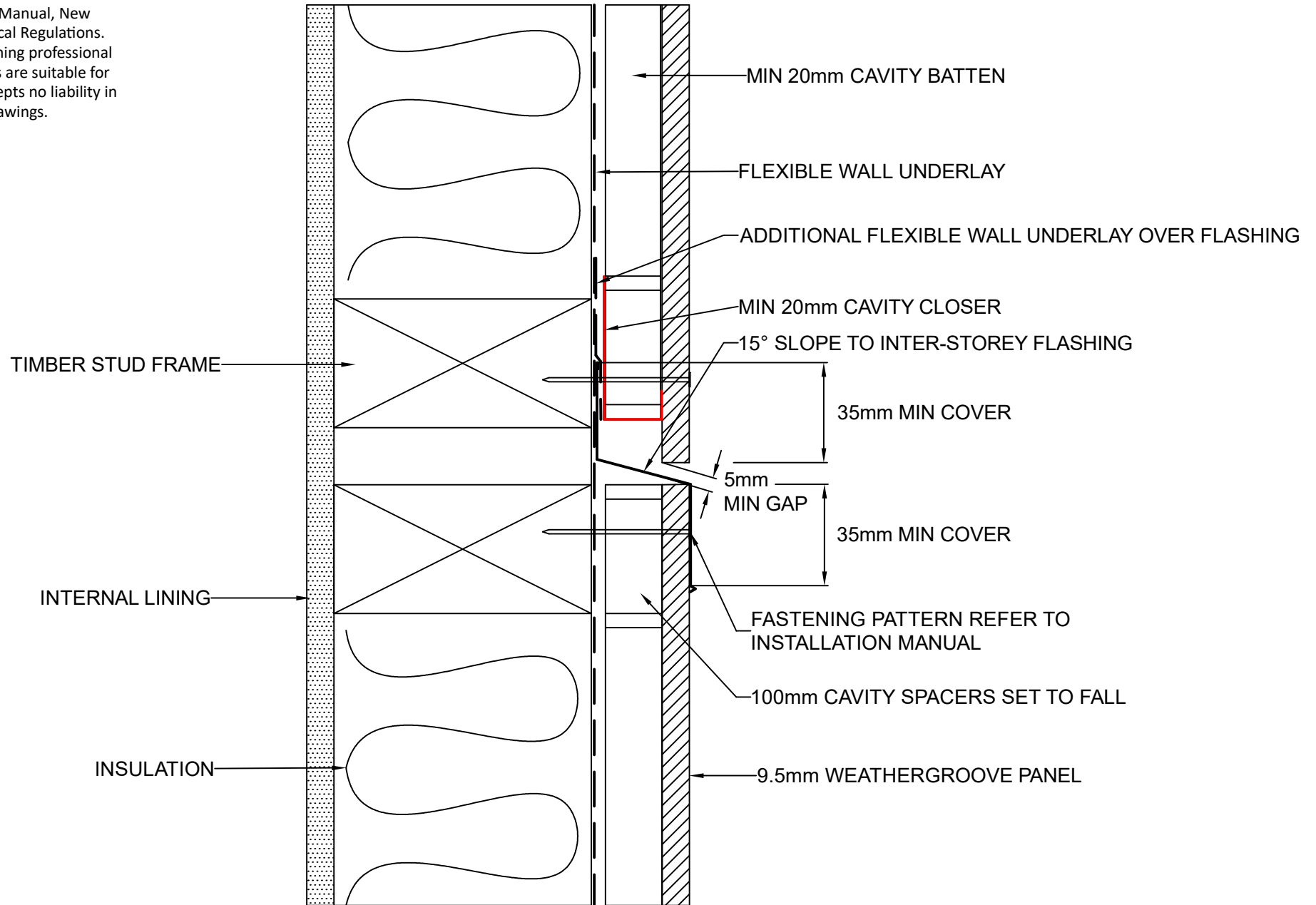

DRAWING NAME:
CAVITY FIX INSTALLATION - INTER-STOREY JUNCTION
(WEATHERGROOVE RANGE)

SCALE:
NTS

DRAWN BY:
A.MOATE

CHECKED BY:
R.STUART

DATE:
02.09.22

DRAWING No.:
NZ-WG-CF-25

SHT SIZE
A4

These drawings are for information only. They do not contain full details required for construction and must be used in conjunction with the current issue Weathertex Installation Manual, New Zealand Building Code and Local Regulations. Weathertex recommends gaining professional advice to ensure the drawings are suitable for your project. Weathertex accepts no liability in respect to the use of these drawings.

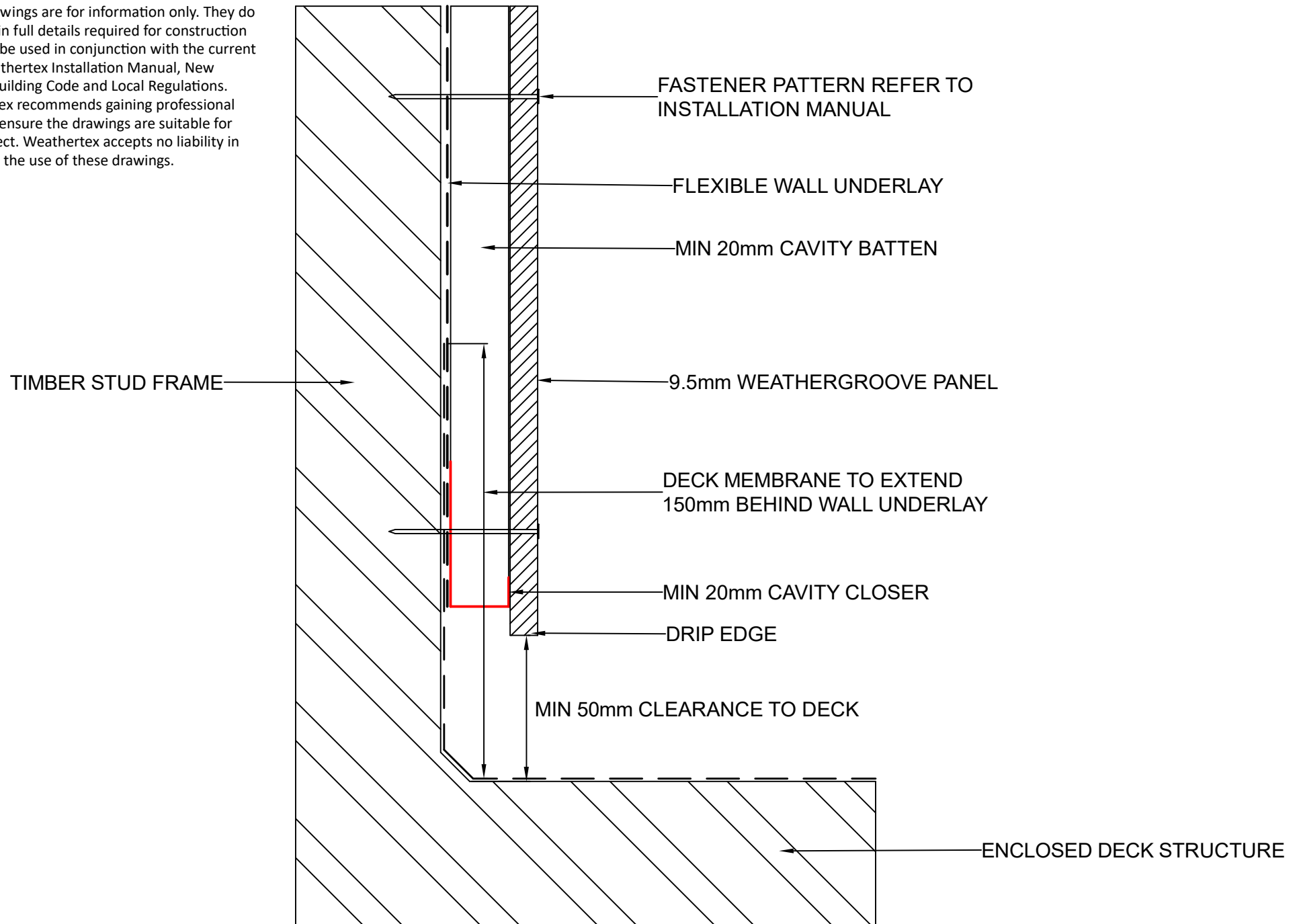

DRAWING NAME:
CAVITY FIX INSTALLATION - MEMBRANE DECK
(WEATHERGROOVE RANGE)

SCALE:
NTS

DRAWN BY:
A.MOATE

CHECKED BY:
R.STUART

DATE:
02.09.22

DRAWING No.:
NZ-WG-CF-26

SHT SIZE
A4

These drawings are for information only. They do not contain full details required for construction and must be used in conjunction with the current issue Weathertex Installation Manual, New Zealand Building Code and Local Regulations. Weathertex recommends gaining professional advice to ensure the drawings are suitable for your project. Weathertex accepts no liability in respect to the use of these drawings.

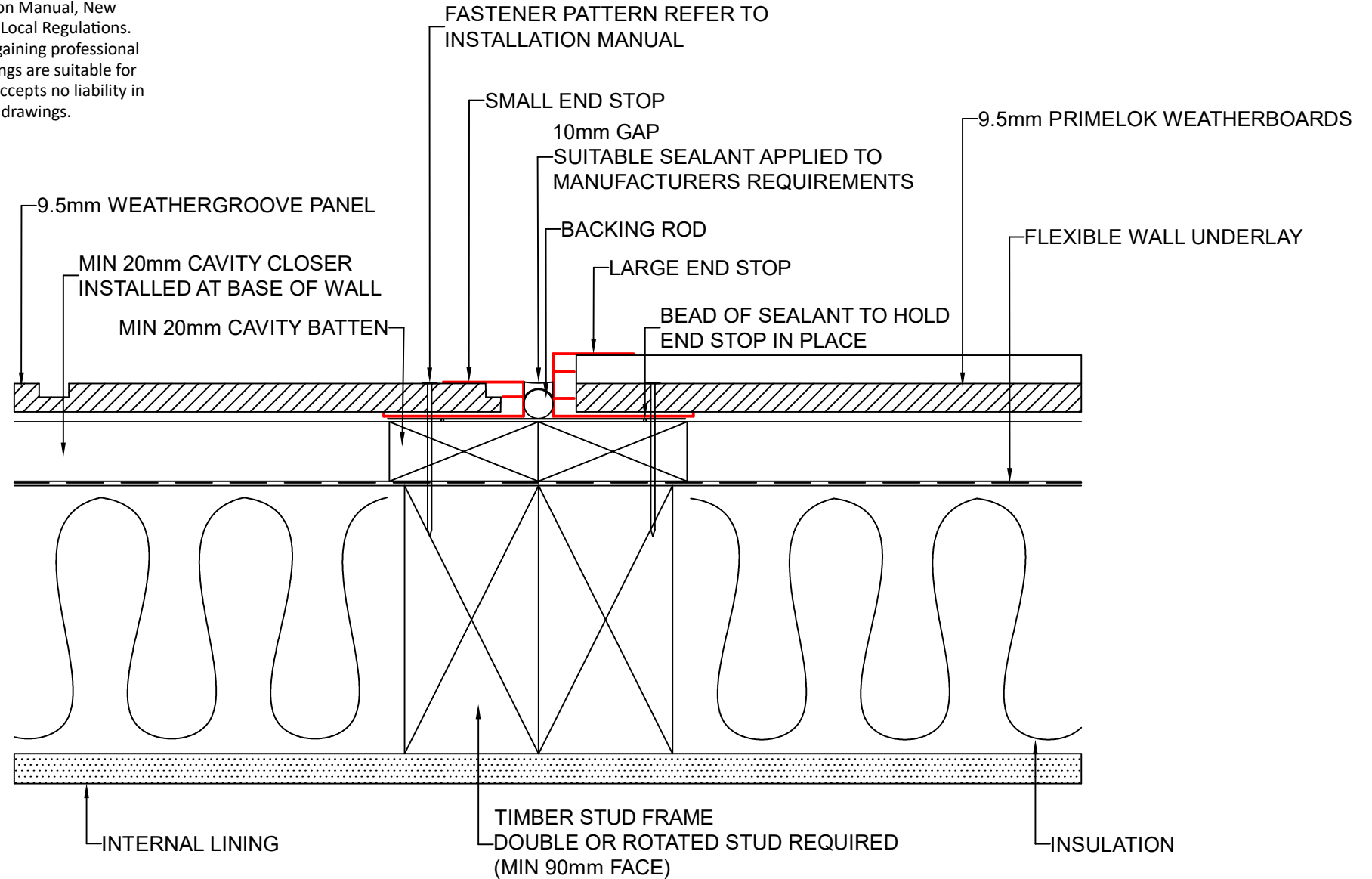

DRAWING NAME:
CAVITY FIX INSTALLATION - BACK TO BACK END STOP
(WEATHERGROOVE RANGE)

SCALE:
NTS

DRAWN BY:
A.MOATE

CHECKED BY:
R.STUART

DATE:
02.09.22

DRAWING No.:
NZ-WG-CF-27

SHT SIZE
A4

These drawings are for information only. They do not contain full details required for construction and must be used in conjunction with the current issue Weathertex Installation Manual, New Zealand Building Code and Local Regulations. Weathertex recommends gaining professional advice to ensure the drawings are suitable for your project. Weathertex accepts no liability in respect to the use of these drawings.

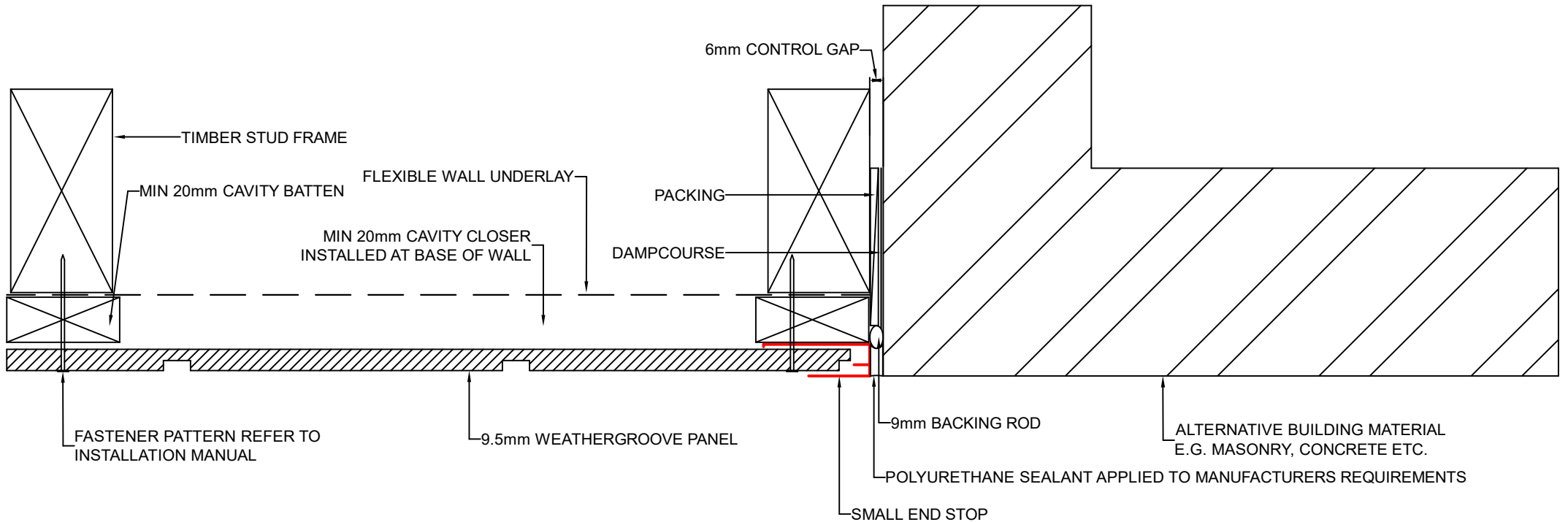

	DRAWING NAME: CAVITY FIX INSTALLATION - END STOP TO ALTERNATIVE MATERIALS (WEATHERGROOVE RANGE)	SCALE:	DRAWN BY:	CHECKED BY:	DATE:	DRAWING No.:	SHT SIZE
		NTS	A.MOATE	R.STUART	02.09.22	NZ-WG-CF-28	A4

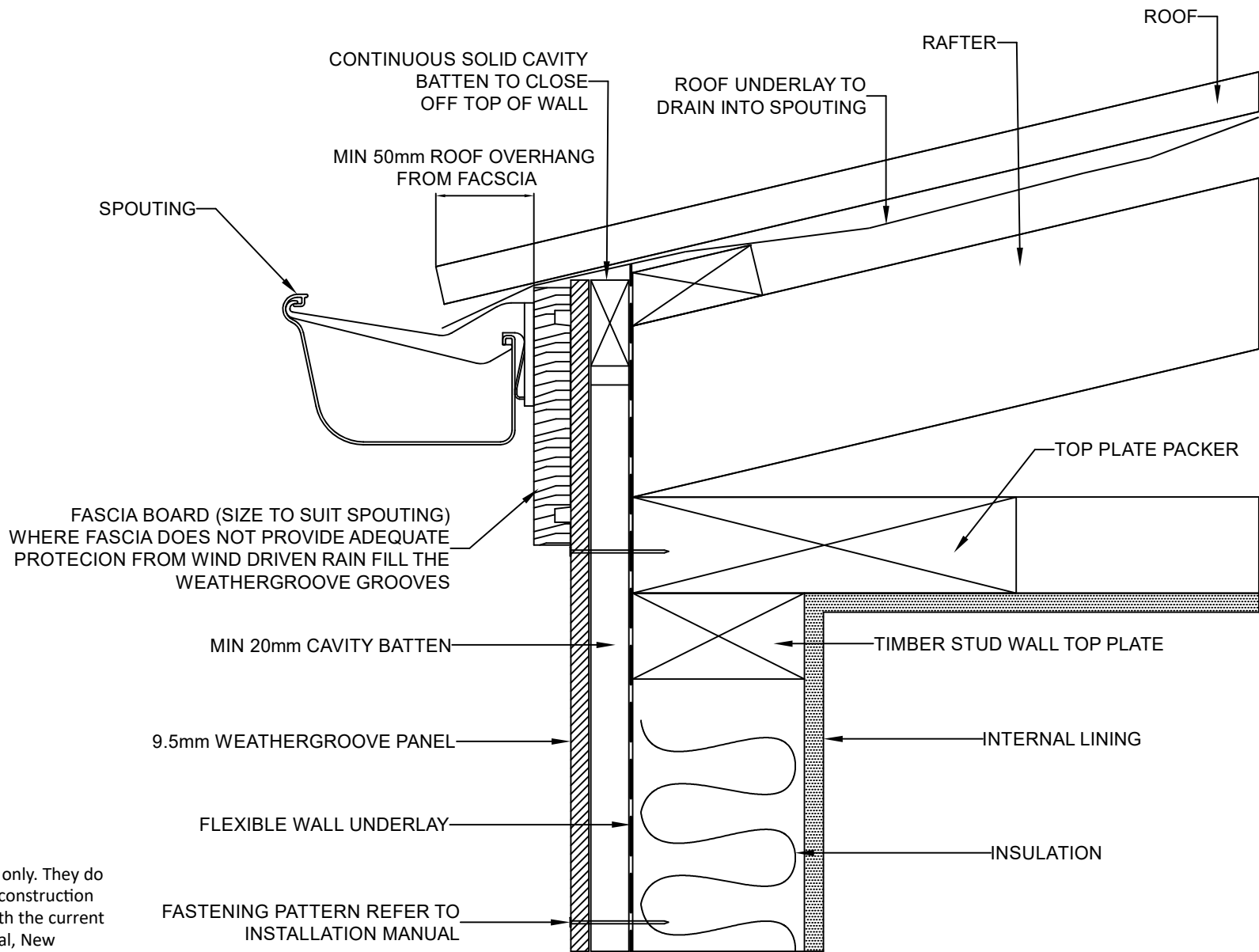

These drawings are for information only. They do not contain full details required for construction and must be used in conjunction with the current issue Weathertex Installation Manual, New Zealand Building Code and Local Regulations. Weathertex recommends gaining professional advice to ensure the drawings are suitable for your project. Weathertex accepts no liability in respect to the use of these drawings.

	DRAWING NAME: CAVITY FIX INSTALLATION - NO SOFFIT (WEATHERGROOVE RANGE)	SCALE: NTS	DRAWN BY: A.MOATE	CHECKED BY: R.STUART	DATE: 29.11.22	DRAWING No.: NZ-WG-CF-29	SHT SIZE A4