

# WEATHERTEX CONSTRUCTION DETAILS

## SELFLOK WEATHERBOARDS

CAVITY &  
STEEL FRAME  
CONSTRUCTION

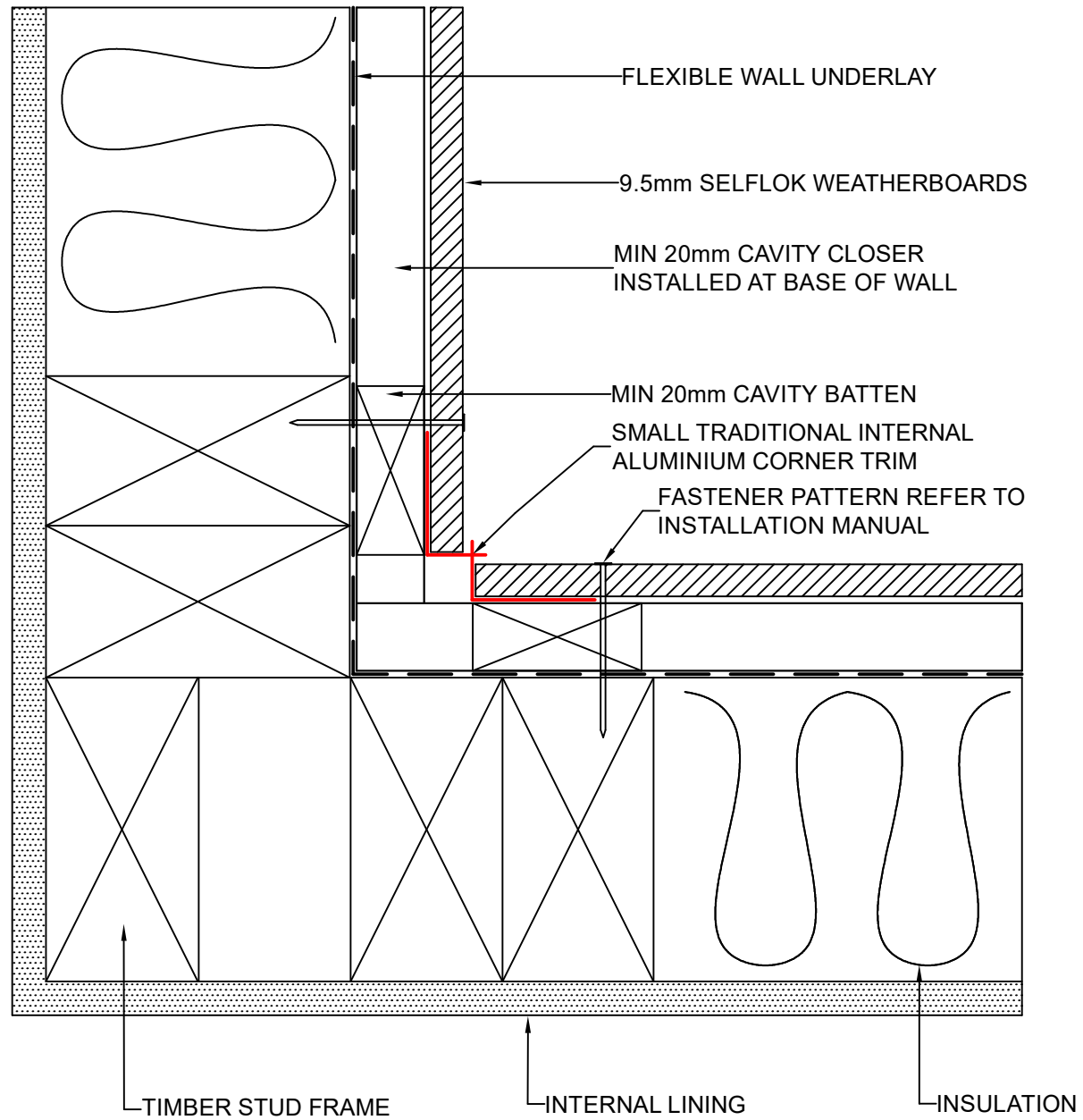

These drawings are for information only. They do not contain full details required for construction and must be used in conjunction with the current issue Weathertex Installation Manual, New Zealand Building Code and Local Regulations. Weathertex recommends gaining professional advice to ensure the drawings are suitable for your project. Weathertex accepts no liability in respect to the use of these drawings.



DRAWING NAME:  
CAVITY FIX INSTALLATION - SMALL INTERNAL CORNER  
(SELFLOK RANGE)

SCALE:  
NTS

DRAWN BY:  
A.MOATE

CHECKED BY:  
R.STUART

DATE:  
02.09.22

DRAWING No.:  
NZ-SL-CF-1

SHT SIZE  
A4

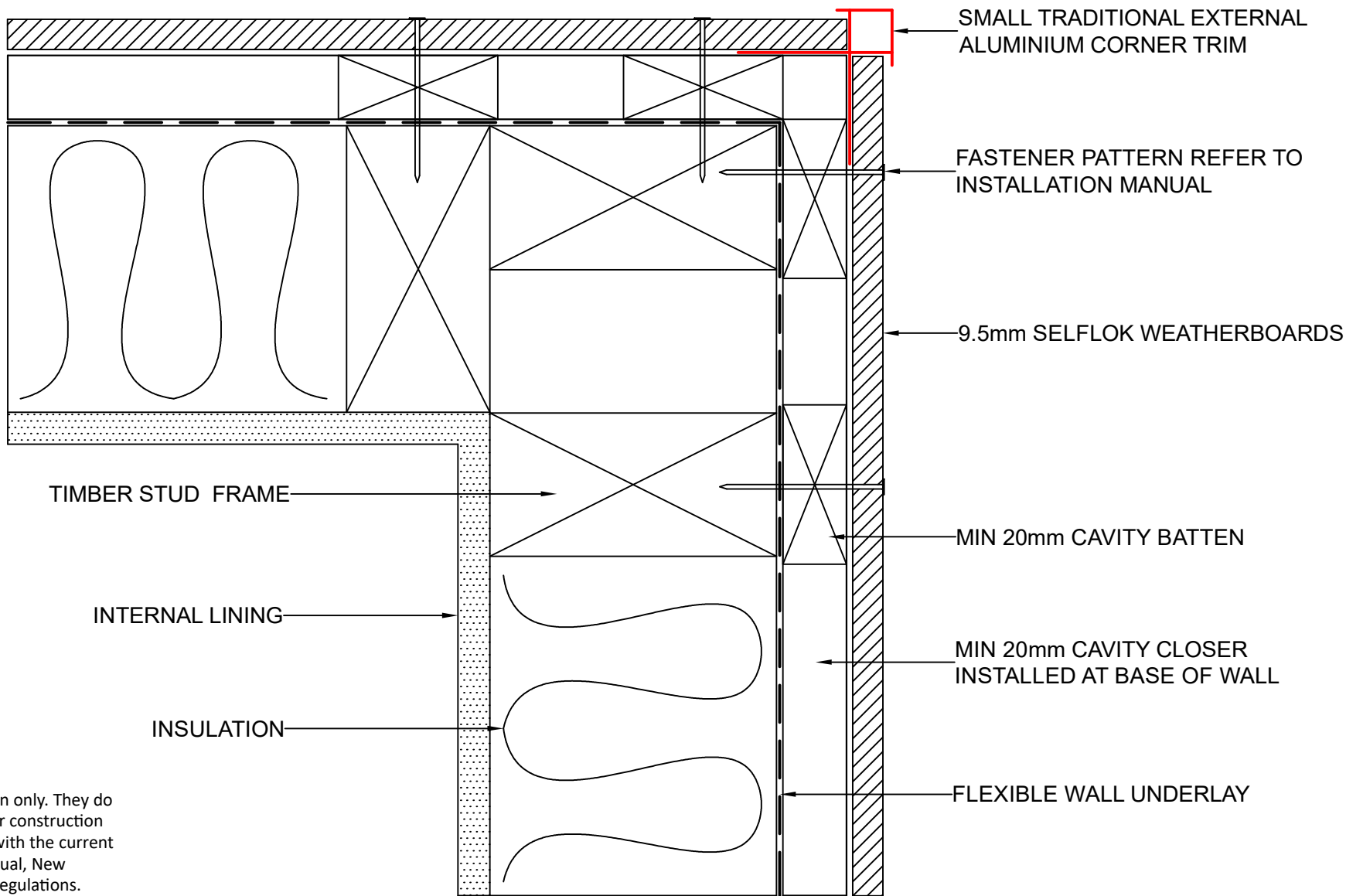

These drawings are for information only. They do not contain full details required for construction and must be used in conjunction with the current issue Weathertex Installation Manual, New Zealand Building Code and Local Regulations. Weathertex recommends gaining professional advice to ensure the drawings are suitable for your project. Weathertex accepts no liability in respect to the use of these drawings.

	DRAWING NAME: CAVITY FIX INSTALLATION - SMALL EXTERNAL CORNER (SELFLOK RANGE)	SCALE: NTS	DRAWN BY: A.MOATE	CHECKED BY: R.STUART	DATE: 02.09.22	DRAWING No.: NZ-SL-CF-2	SHT SIZE A4

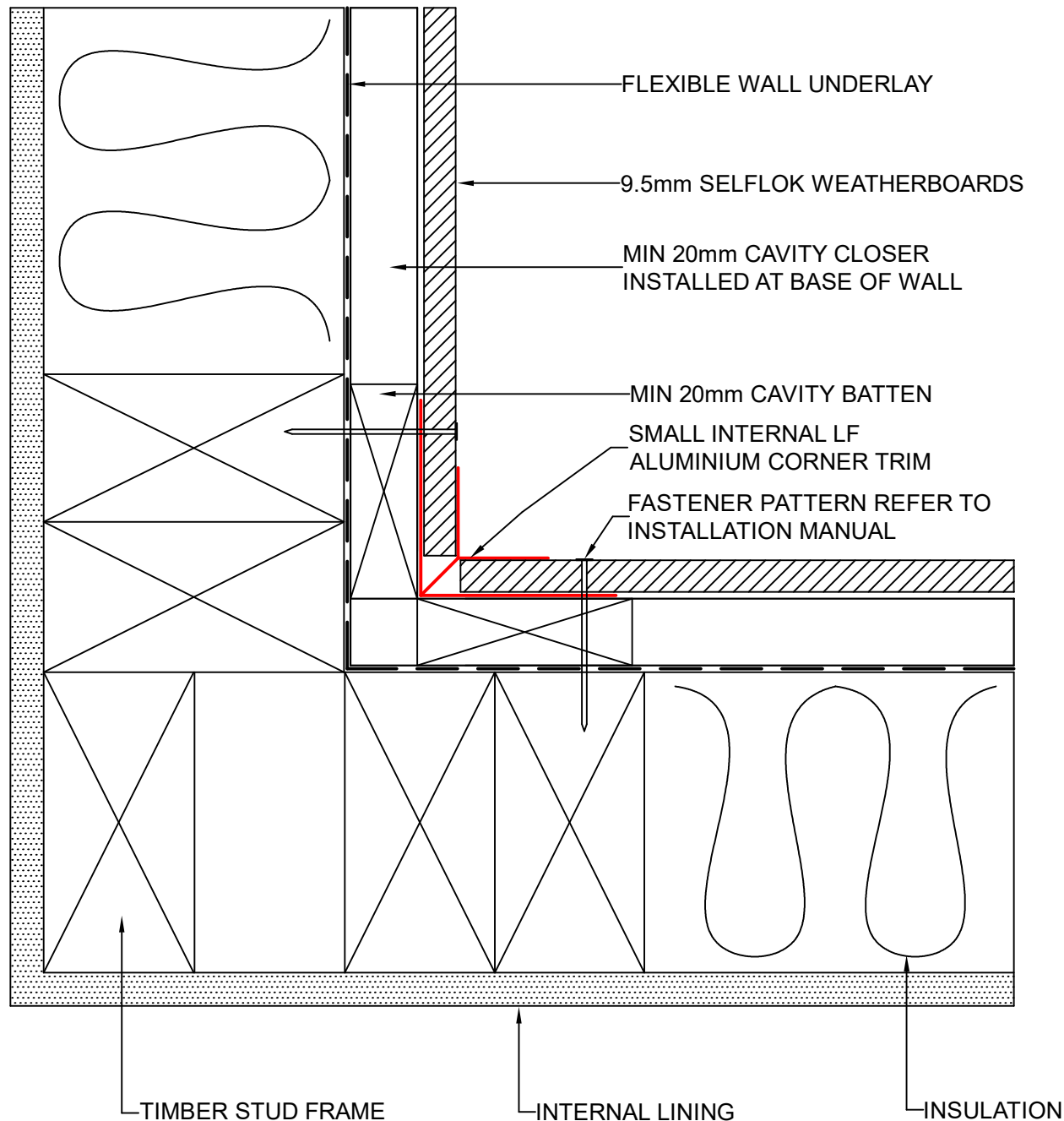

These drawings are for information only. They do not contain full details required for construction and must be used in conjunction with the current issue Weathertex Installation Manual, New Zealand Building Code and Local Regulations. Weathertex recommends gaining professional advice to ensure the drawings are suitable for your project. Weathertex accepts no liability in respect to the use of these drawings.



DRAWING NAME:  
 CAVITY FIX INSTALLATION - SMALL INTERNAL LF CORNER  
 (SELFLOK RANGE)

SCALE:  
 NTS

DRAWN BY:  
 A.MOATE

CHECKED BY:  
 R.STUART

DATE:  
 02.09.22

DRAWING No.:  
 NZ-SL-CF-3

SHT SIZE  
 A4

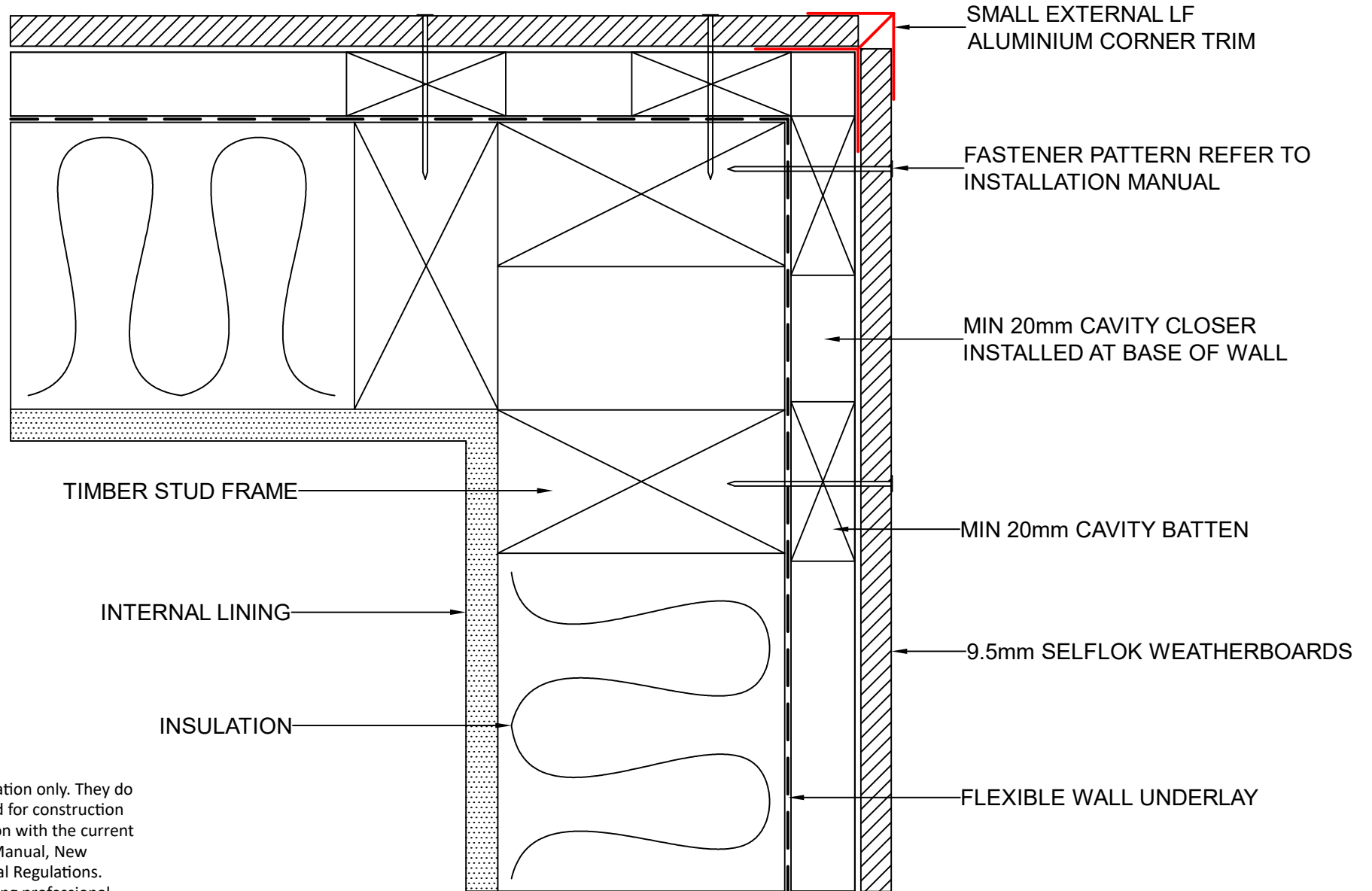

These drawings are for information only. They do not contain full details required for construction and must be used in conjunction with the current issue Weathertex Installation Manual, New Zealand Building Code and Local Regulations. Weathertex recommends gaining professional advice to ensure the drawings are suitable for your project. Weathertex accepts no liability in respect to the use of these drawings.



DRAWING NAME:  
CAVITY FIX INSTALLATION - SMALL EXTERNAL LF CORNER  
(SELFLOK RANGE)

SCALE:

NTS

DRAWN BY:

A.MOATE

CHECKED BY:

R.STUART

DATE:

02.09.22

DRAWING No.:

NZ-SL-CF-4

SHT SIZE

A4

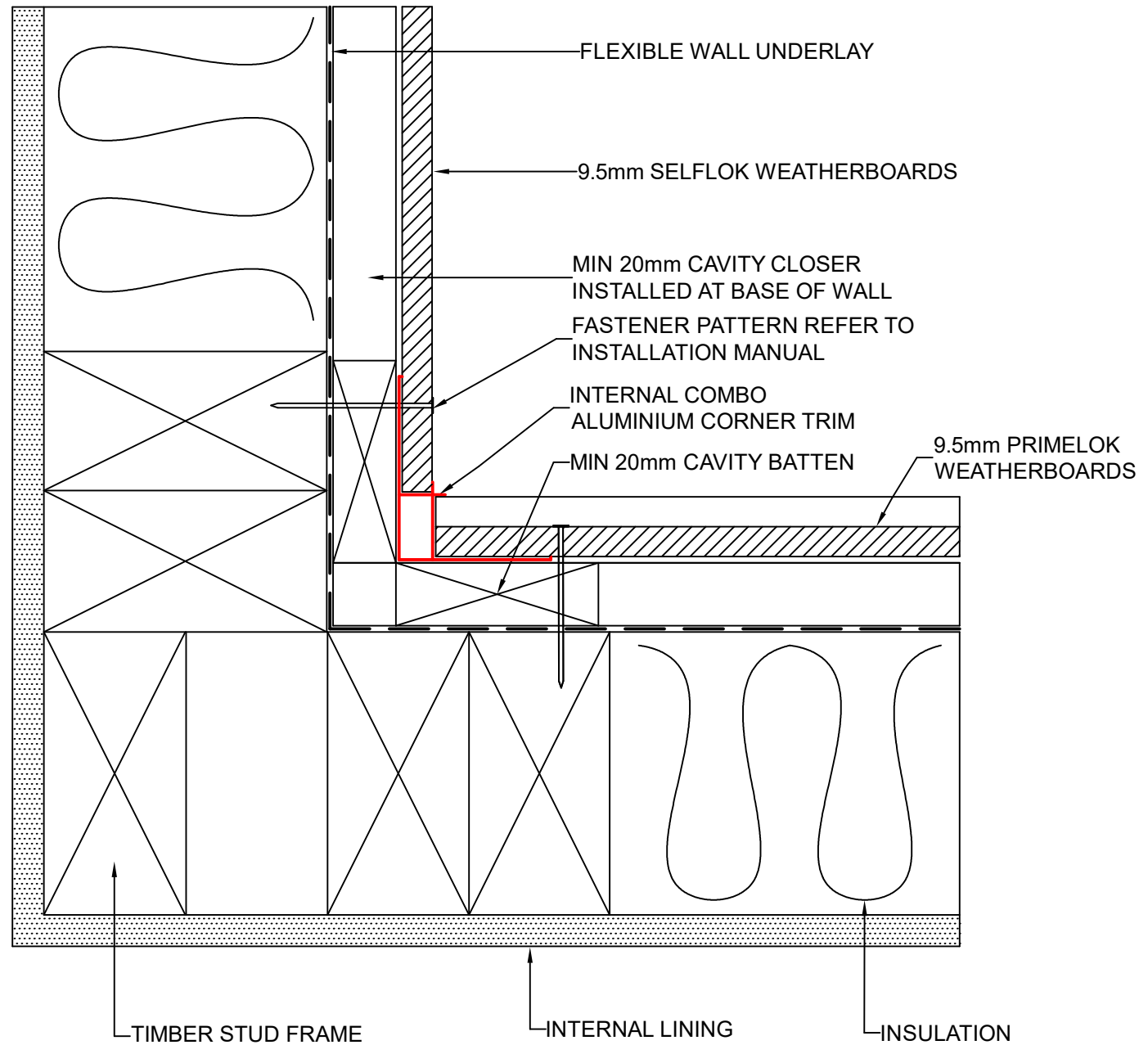

These drawings are for information only. They do not contain full details required for construction and must be used in conjunction with the current issue Weathertex Installation Manual, New Zealand Building Code and Local Regulations. Weathertex recommends gaining professional advice to ensure the drawings are suitable for your project. Weathertex accepts no liability in respect to the use of these drawings.



DRAWING NAME:  
 CAVITY FIX INSTALLATION - INTERNAL COMBO CORNER  
 (SELFLOK RANGE)

SCALE:

NTS

DRAWN BY:

A.MOATE

CHECKED BY:

R.STUART

DATE:

02.09.22

DRAWING No.:

NZ-SL-CF-5

SHT SIZE

A4

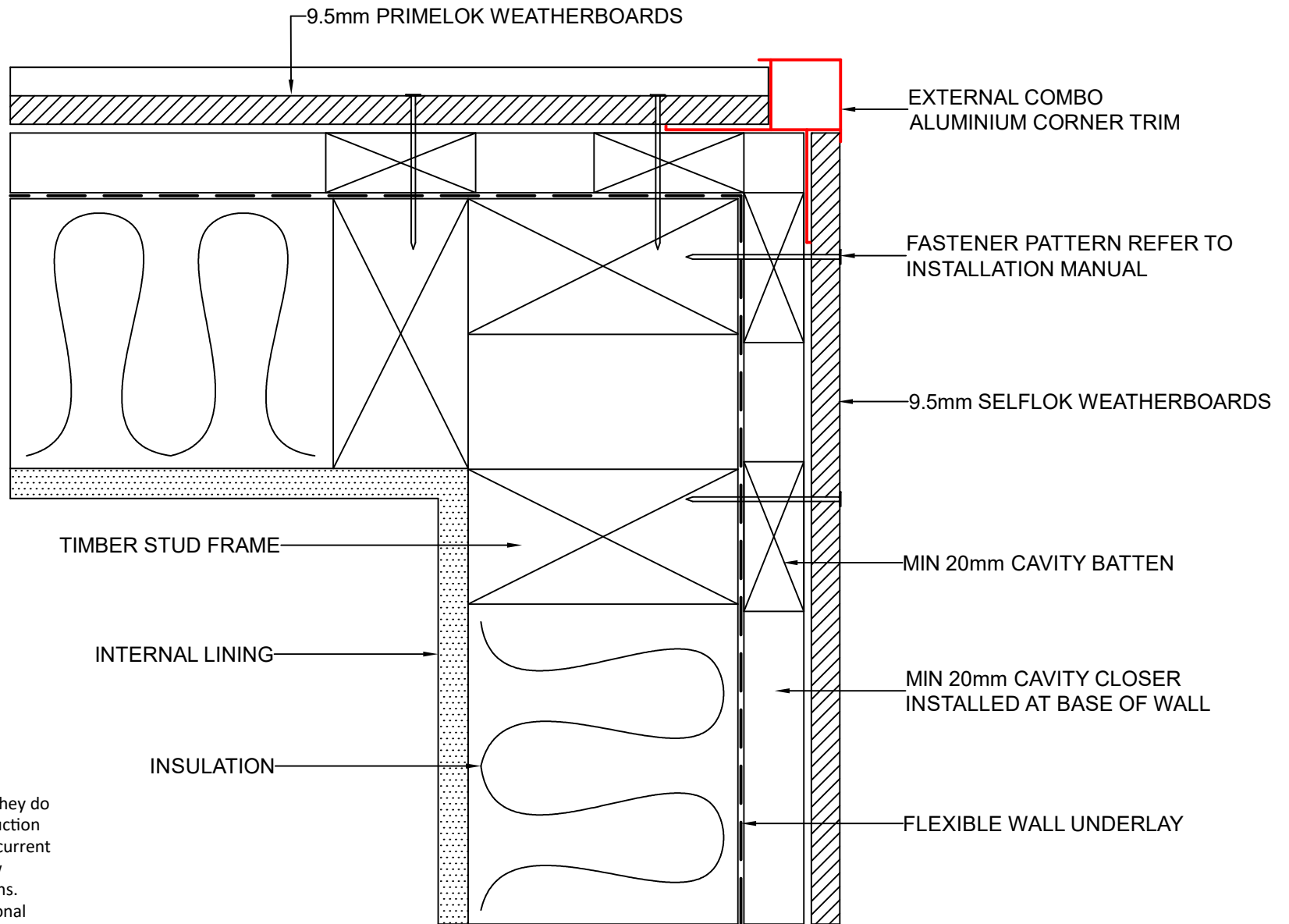

These drawings are for information only. They do not contain full details required for construction and must be used in conjunction with the current issue Weathertex Installation Manual, New Zealand Building Code and Local Regulations. Weathertex recommends gaining professional advice to ensure the drawings are suitable for your project. Weathertex accepts no liability in respect to the use of these drawings.



DRAWING NAME:  
CAVITY FIX INSTALLATION - EXTERNAL COMBO CORNER  
(SELFLOK RANGE)

SCALE:

NTS

DRAWN BY:

A.MOATE

CHECKED BY:

R.STUART

DATE:

02.09.22

DRAWING No.:

NZ-SL-CF-6

SHT SIZE

A4

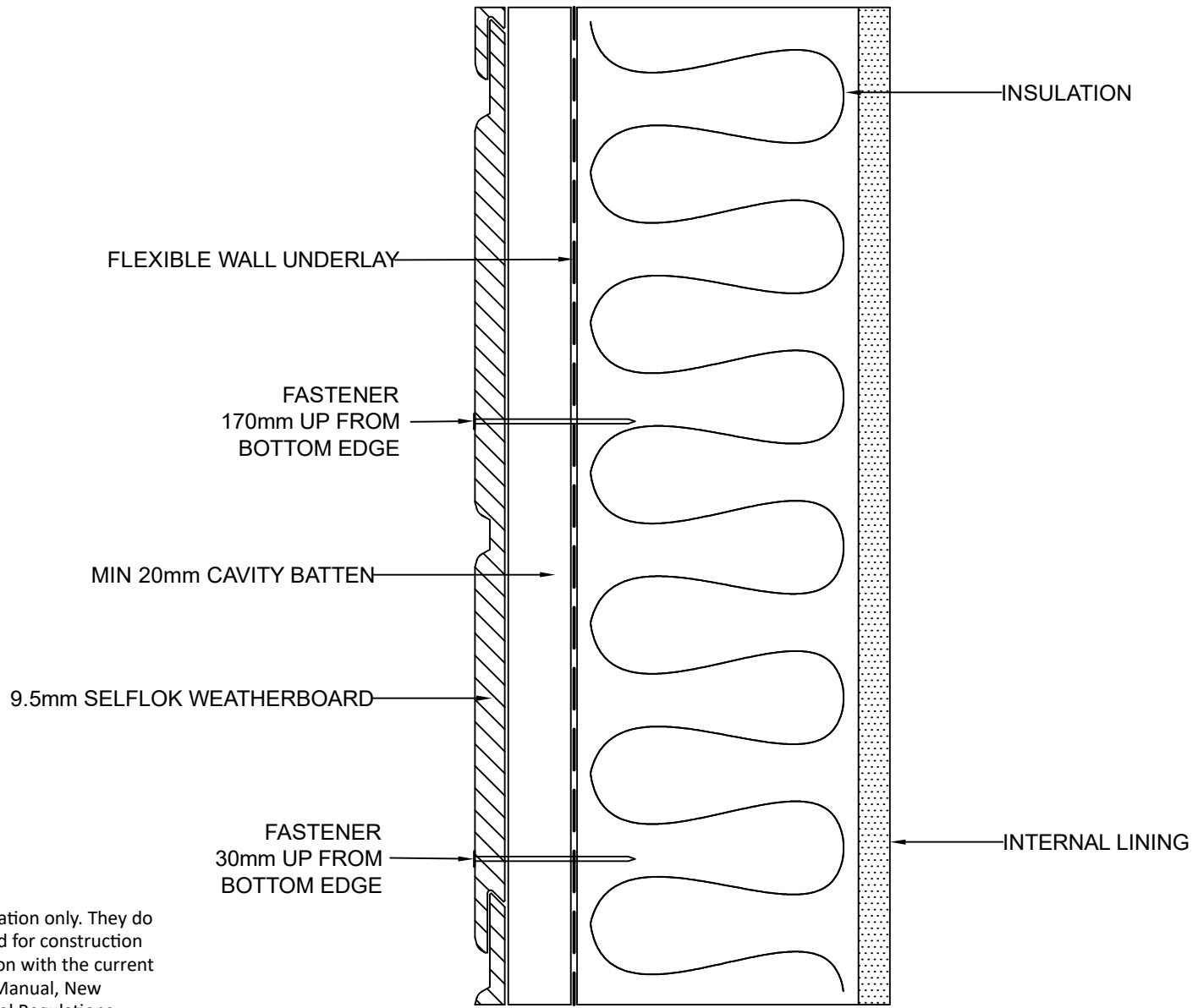

These drawings are for information only. They do not contain full details required for construction and must be used in conjunction with the current issue Weathertex Installation Manual, New Zealand Building Code and Local Regulations. Weathertex recommends gaining professional advice to ensure the drawings are suitable for your project. Weathertex accepts no liability in respect to the use of these drawings.



DRAWING NAME:  
CAVITY FIX INSTALLATION - TRADITIONAL FASTENING PATTERN  
(SELFLOK RANGE)

SCALE:  
NTS

DRAWN BY:  
A.MOATE

CHECKED BY:  
R.STUART

DATE:  
02.09.22

DRAWING No.:  
NZ-SL-CF-7

SHT SIZE  
A4



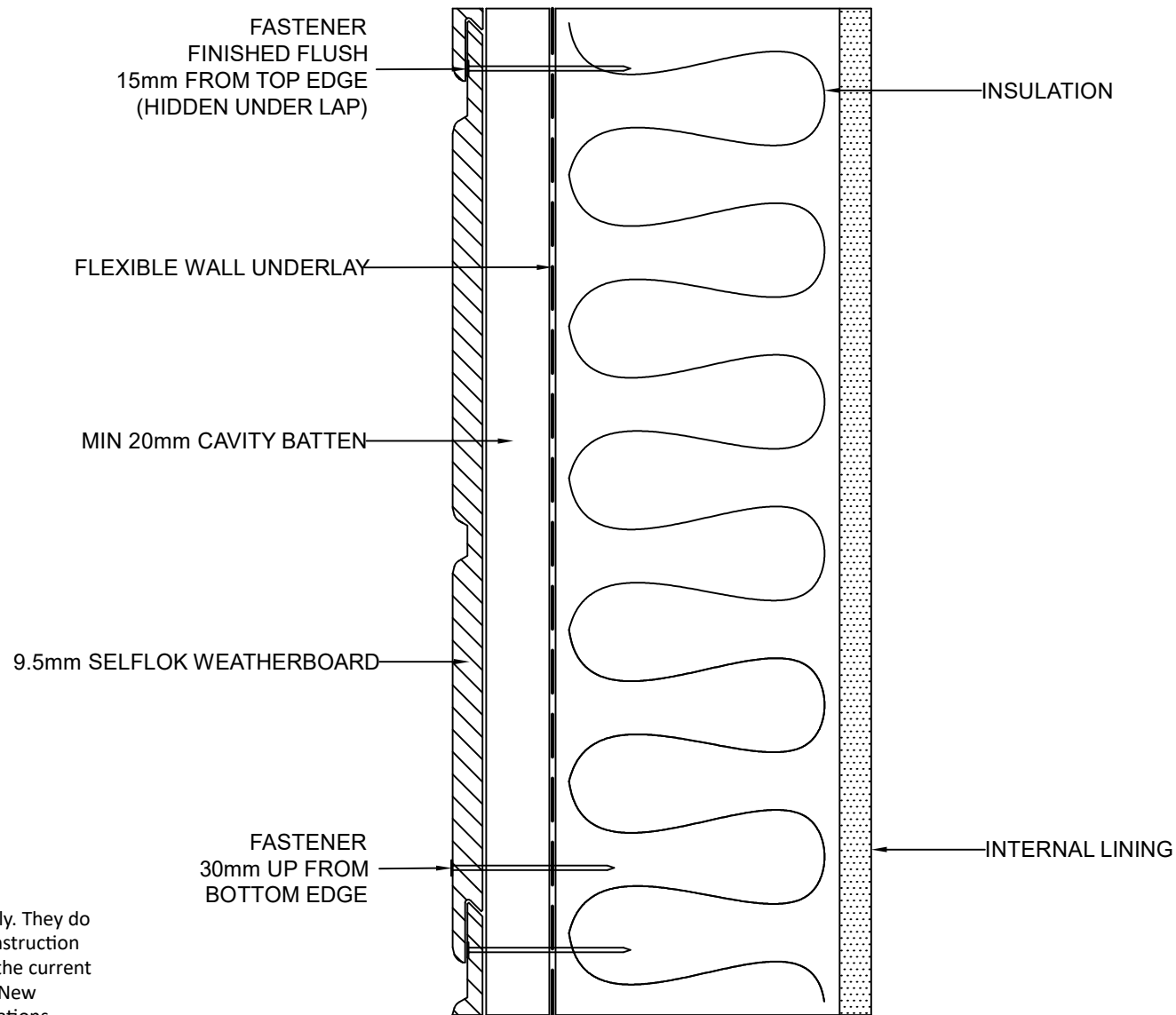

These drawings are for information only. They do not contain full details required for construction and must be used in conjunction with the current issue Weathertex Installation Manual, New Zealand Building Code and Local Regulations. Weathertex recommends gaining professional advice to ensure the drawings are suitable for your project. Weathertex accepts no liability in respect to the use of these drawings.



DRAWING NAME:  
CAVITY FIX INSTALLATION - SEMI CONCEALED FASTENING PATTERN  
(SELFLOK RANGE)

SCALE:  
NTS

DRAWN BY:  
A.MOATE

CHECKED BY:  
R.STUART

DATE:  
02.09.22

DRAWING No.:  
NZ-SL-CF-8

SHT SIZE  
A4

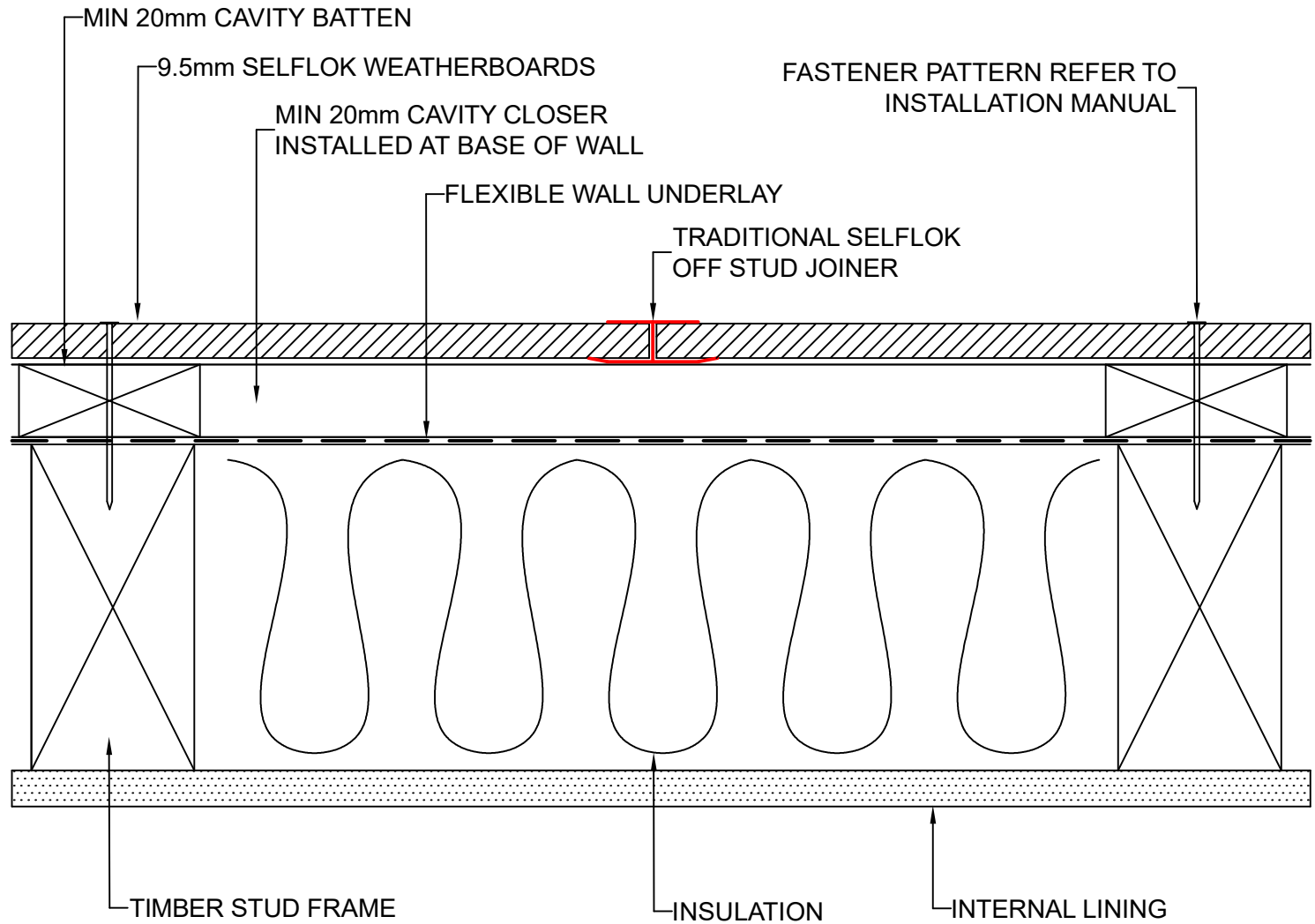

These drawings are for information only. They do not contain full details required for construction and must be used in conjunction with the current issue Weathertex Installation Manual, New Zealand Building Code and Local Regulations. Weathertex recommends gaining professional advice to ensure the drawings are suitable for your project. Weathertex accepts no liability in respect to the use of these drawings.



DRAWING NAME:  
CAVITY FIX INSTALLATION - TRADITIONAL JOINING  
(SELFLOK RANGE)

SCALE:  
NTS

DRAWN BY:  
A.MOATE

CHECKED BY:  
R.STUART

DATE:  
02.09.22

DRAWING No.:  
NZ-SL-CF-9

SHT SIZE  
A4

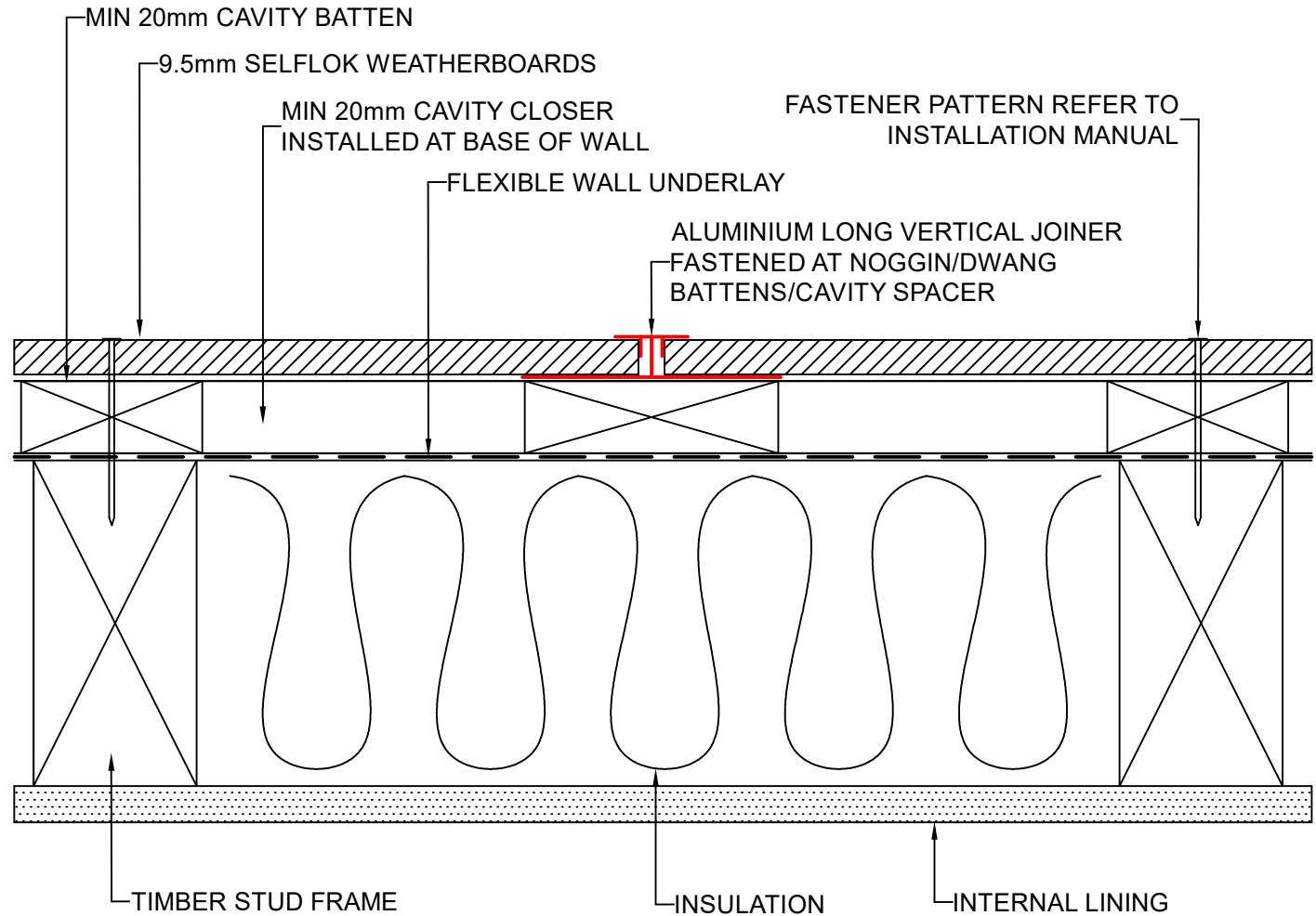

These drawings are for information only. They do not contain full details required for construction and must be used in conjunction with the current issue Weathertex Installation Manual, New Zealand Building Code and Local Regulations. Weathertex recommends gaining professional advice to ensure the drawings are suitable for your project. Weathertex accepts no liability in respect to the use of these drawings.



DRAWING NAME:  
CAVITY FIX INSTALLATION - LONG VERTICAL JOINER  
(SELFLOK RANGE)

SCALE:  
NTS

DRAWN BY:  
A.MOATE

CHECKED BY:  
R.STUART

DATE:  
02.09.22

DRAWING No.:  
NZ-SL-CF-10

SHT SIZE  
A4

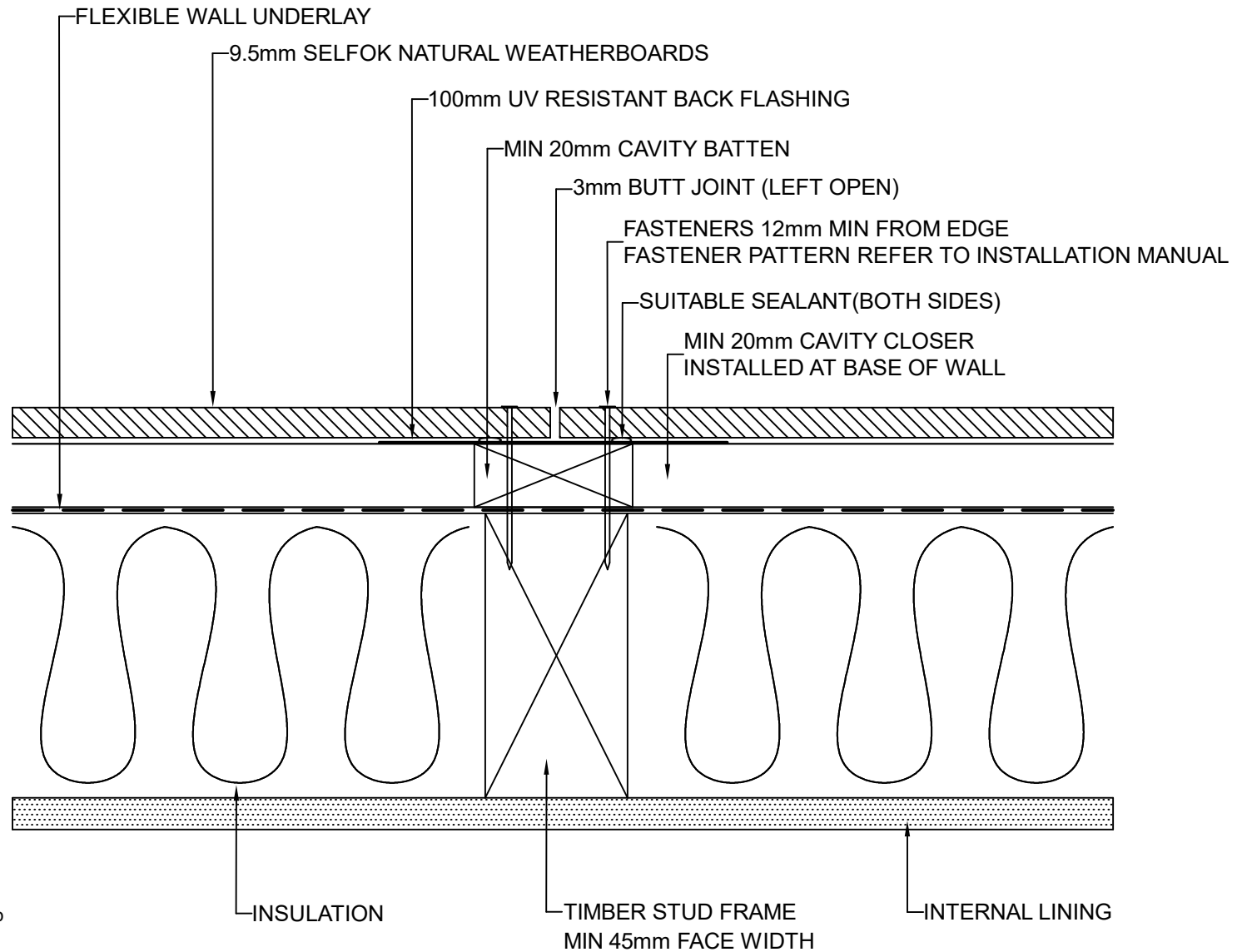

These drawings are for information only. They do not contain full details required for construction and must be used in conjunction with the current issue Weathertex Installation Manual, New Zealand Building Code and Local Regulations. Weathertex recommends gaining professional advice to ensure the drawings are suitable for your project. Weathertex accepts no liability in respect to the use of these drawings.



DRAWING NAME:  
CAVITY FIX INSTALLATION - BUTT JOIN  
(SELFLOK NATURAL RANGE)

SCALE:  
NTS

DRAWN BY:  
A.MOATE

CHECKED BY:  
R.STUART

DATE:  
02.09.22

DRAWING No.:  
NZ-SL-CF-11

SHT SIZE  
A4

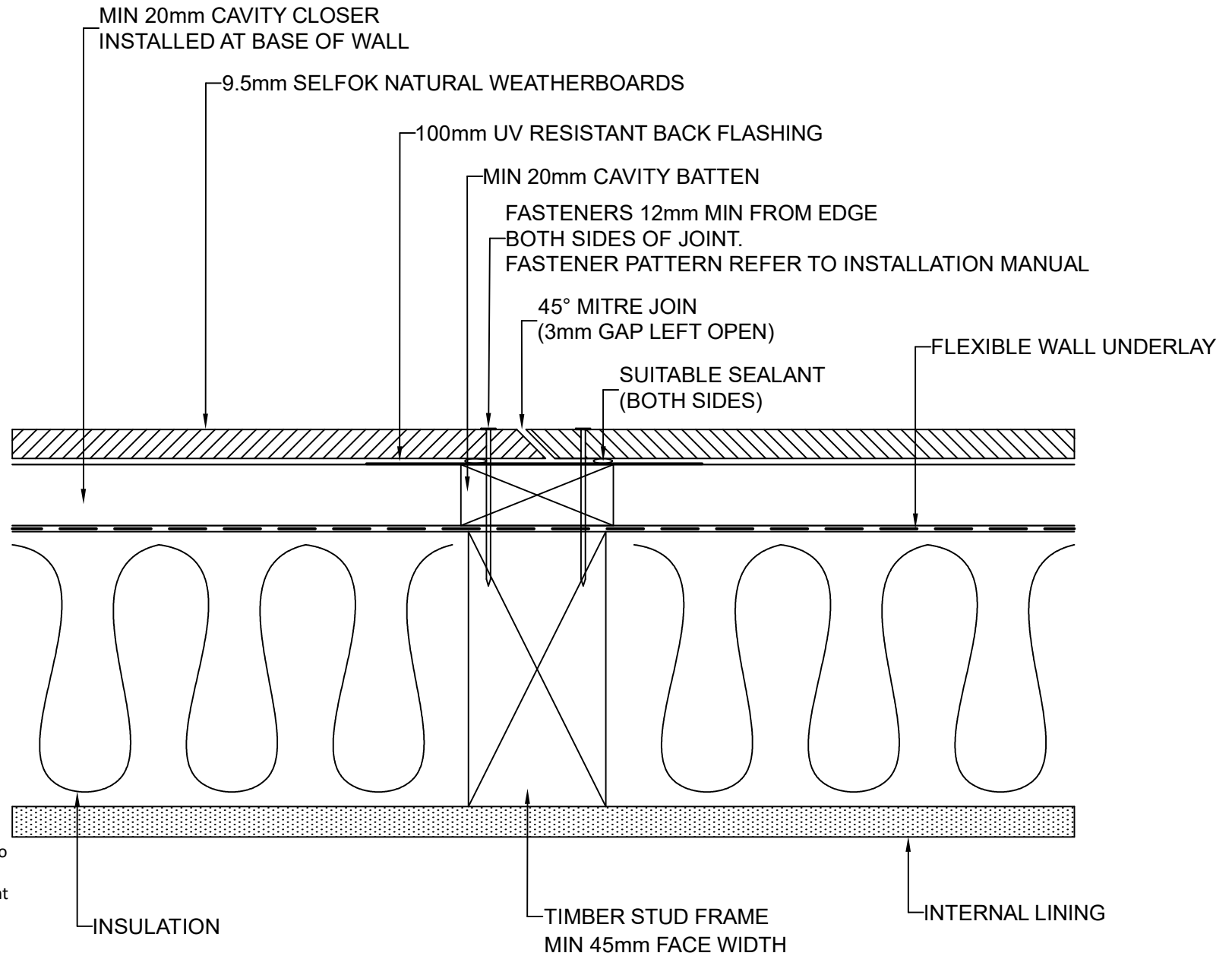

These drawings are for information only. They do not contain full details required for construction and must be used in conjunction with the current issue Weathertex Installation Manual, New Zealand Building Code and Local Regulations. Weathertex recommends gaining professional advice to ensure the drawings are suitable for your project. Weathertex accepts no liability in respect to the use of these drawings.



DRAWING NAME:  
CAVITY FIX INSTALLATION - MITRE JOIN  
(SELFOK NATURAL RANGE)

SCALE:  
NTS

DRAWN BY:  
A.MOATE

CHECKED BY:  
R.STUART

DATE:  
02.09.22

DRAWING No.:  
NZ-SL-CF-12

SHT SIZE  
A4

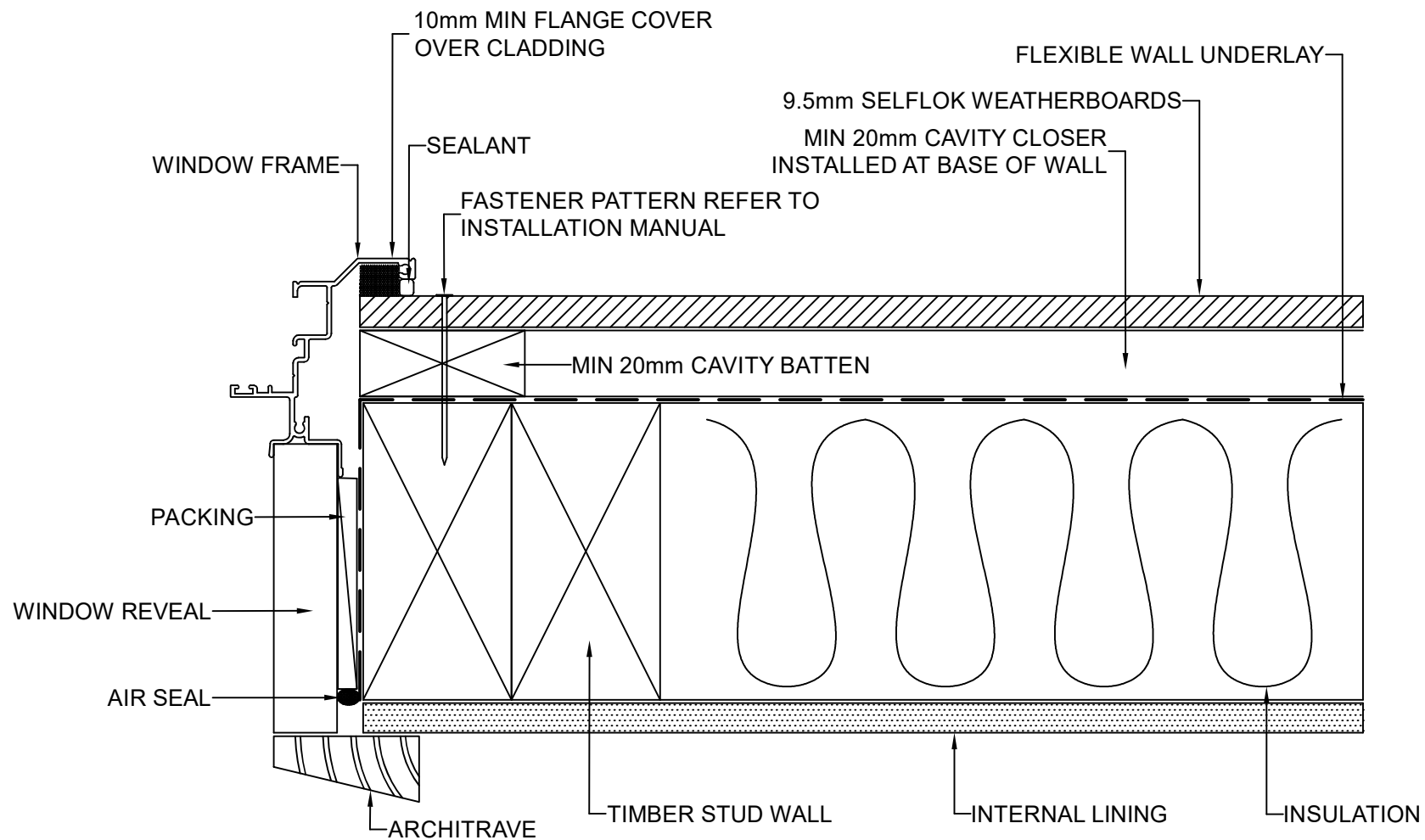

These drawings are for information only. They do not contain full details required for construction and must be used in conjunction with the current issue Weathertex Installation Manual, New Zealand Building Code and Local Regulations. Weathertex recommends gaining professional advice to ensure the drawings are suitable for your project. Weathertex accepts no liability in respect to the use of these drawings.



DRAWING NAME:  
CAVITY FIX INSTALLATION - WINDOW JAMB  
(SELFLOK RANGE)

SCALE:

NTS

DRAWN BY:

A.MOATE

CHECKED BY:

R.STUART

DATE:

02.09.22

DRAWING No.:

NZ-SL-CF-13

SHT SIZE

A4

These drawings are for information only. They do not contain full details required for construction and must be used in conjunction with the current issue Weathertex Installation Manual, New Zealand Building Code and Local Regulations. Weathertex recommends gaining professional advice to ensure the drawings are suitable for your project. Weathertex accepts no liability in respect to the use of these drawings.

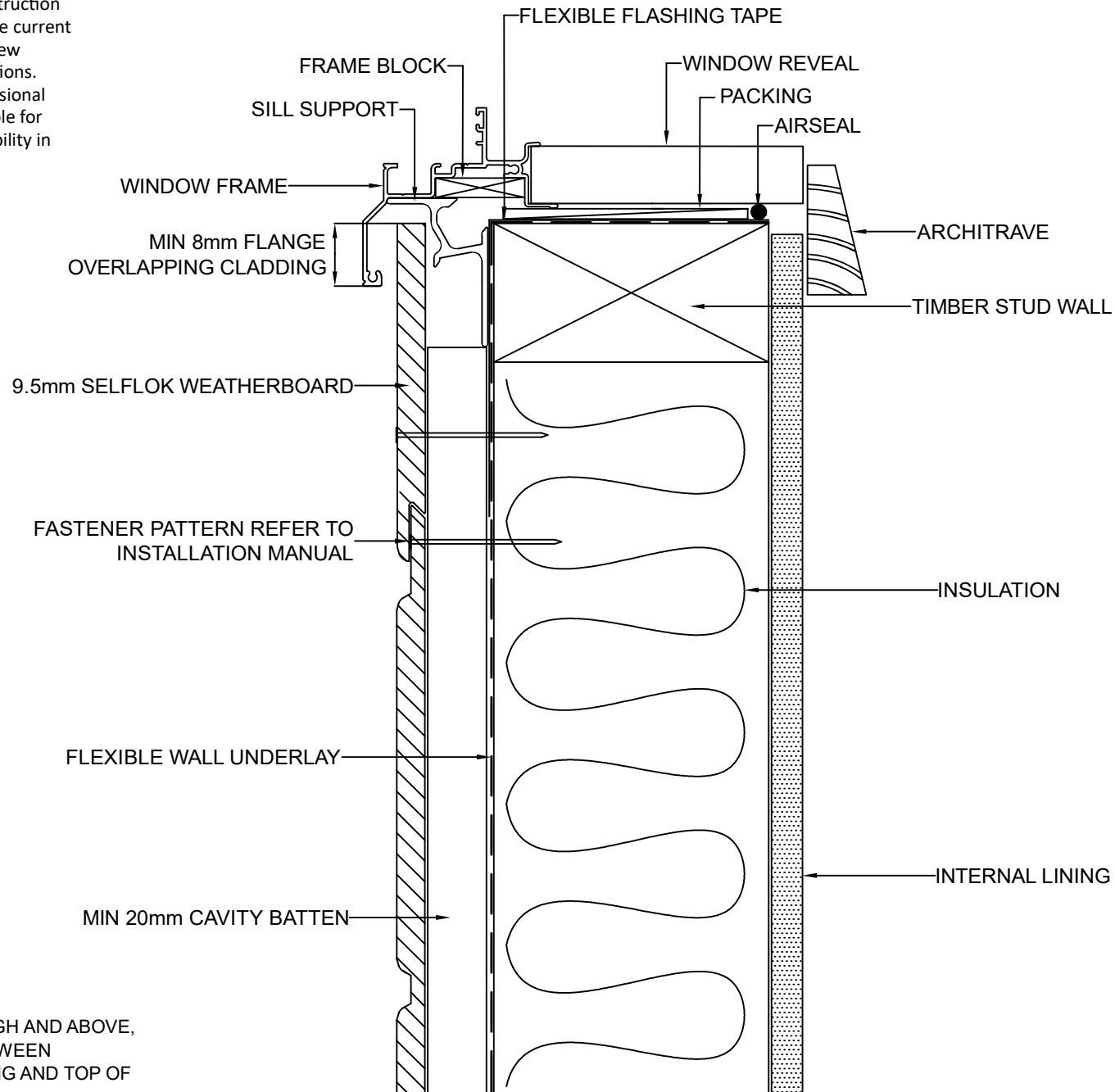

NOTE: IN WIND AREAS OF VERY HIGH AND ABOVE, SEALANT MUST BE INSTALLED BETWEEN UNDERSIDE OF THE HEAD FLASHING AND TOP OF THE WINDOW HEAD FLANGE



DRAWING NAME:  
CAVITY FIX INSTALLATION - WINDOW SILL  
(SELFLOK RANGE)

SCALE:  
NTS

DRAWN BY:  
A.MOATE

CHECKED BY:  
R.STUART

DATE:  
02.09.22

DRAWING No.:  
NZ-SL-CF-14

SHT SIZE  
A4

These drawings are for information only. They do not contain full details required for construction and must be used in conjunction with the current issue Weathertex Installation Manual, New Zealand Building Code and Local Regulations. Weathertex recommends gaining professional advice to ensure the drawings are suitable for your project. Weathertex accepts no liability in respect to the use of these drawings.

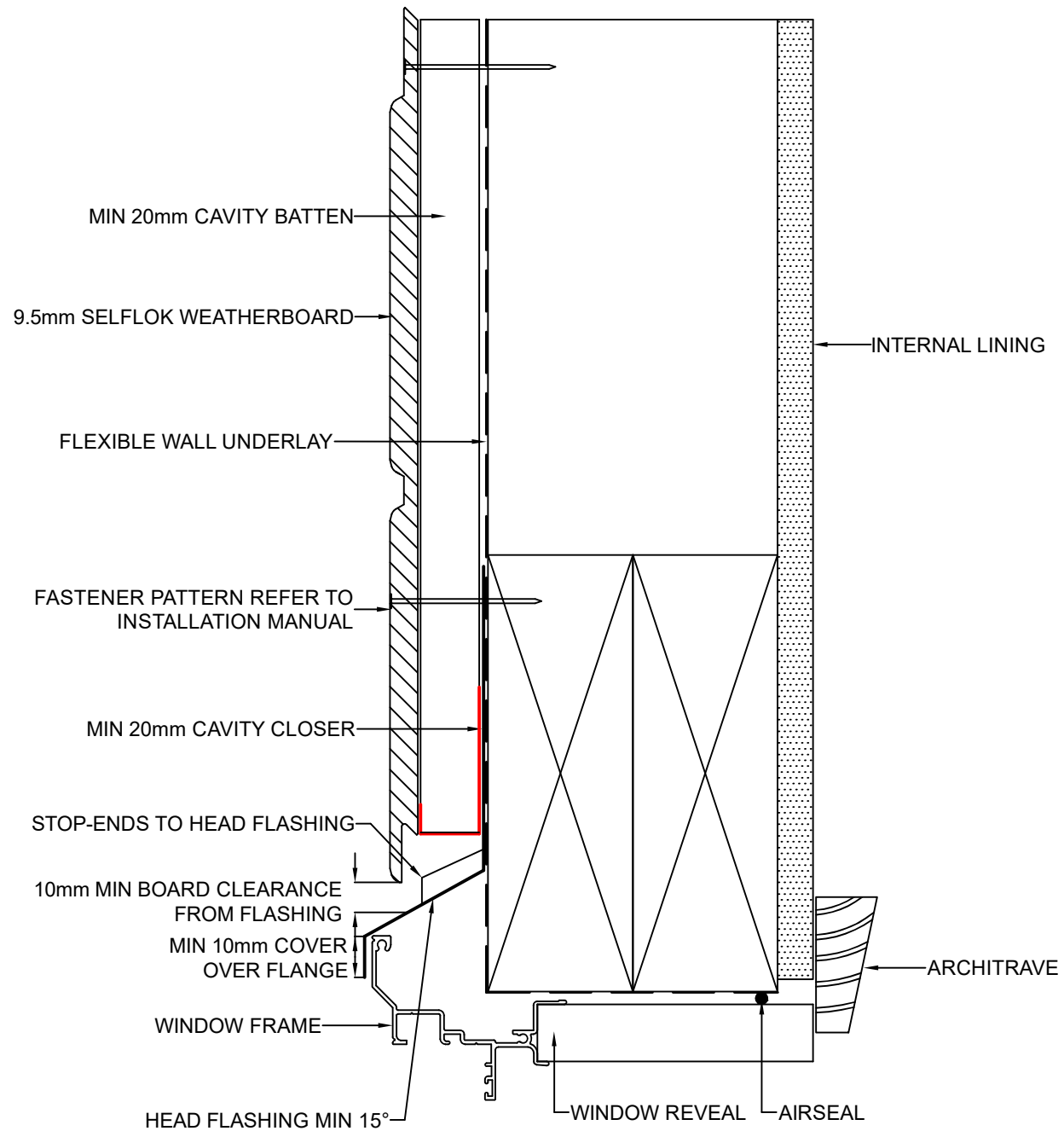

NOTE: IN WIND AREAS OF VERY HIGH AND ABOVE, SEALANT MUST BE INSTALLED BETWEEN UNDERSIDE OF THE HEAD FLASHING AND TOP OF THE WINDOW HEAD FLANGE



DRAWING NAME:  
CAVITY FIX INSTALLATION - WINDOW LINTEL  
(SELFLOK RANGE)

SCALE:

NTS

DRAWN BY:

A.MOATE

CHECKED BY:

R.STUART

DATE:

02.09.22

DRAWING No.:

NZ-SL-CF-15

SHT SIZE

A4



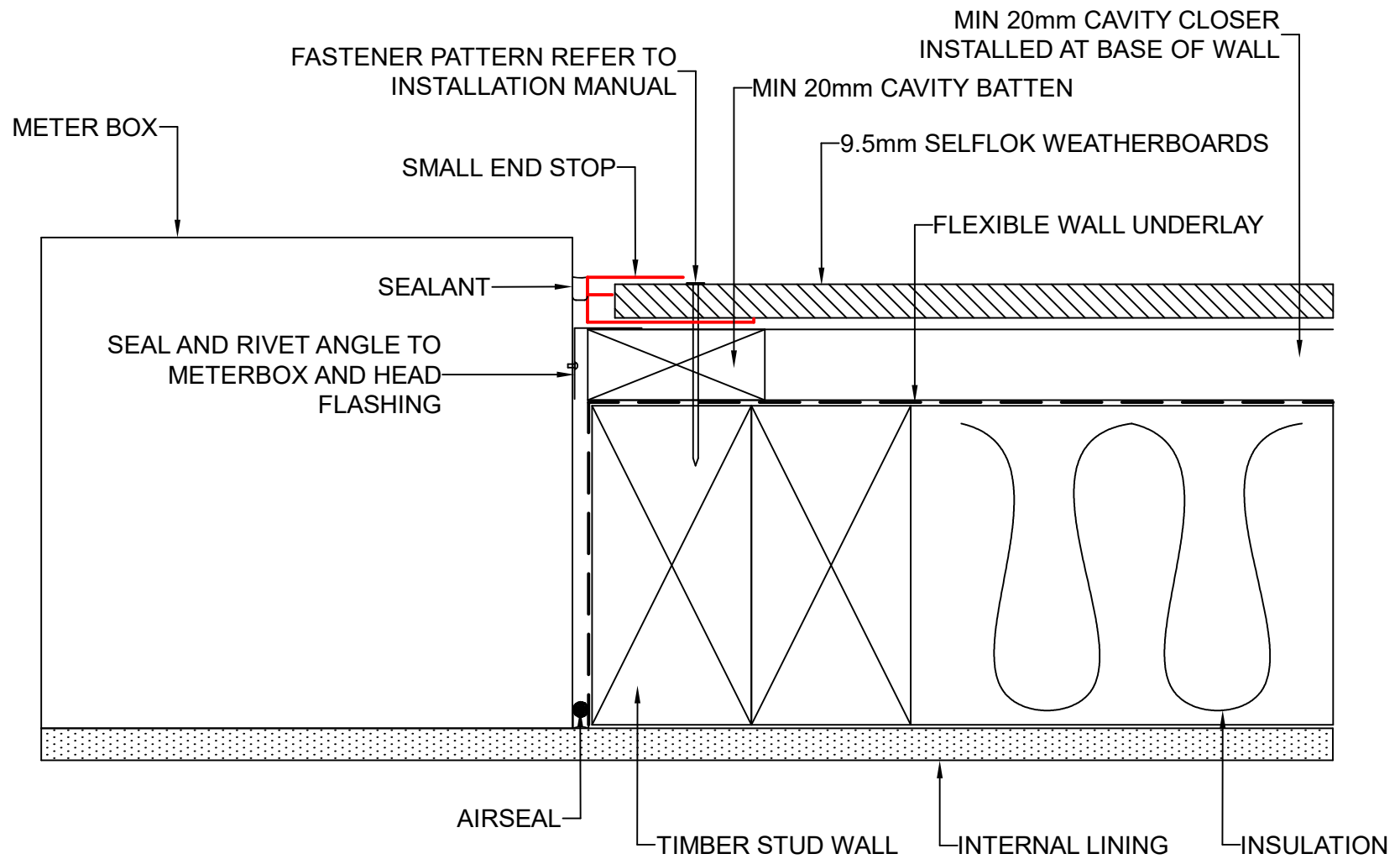

These drawings are for information only. They do not contain full details required for construction and must be used in conjunction with the current issue Weathertex Installation Manual, New Zealand Building Code and Local Regulations. Weathertex recommends gaining professional advice to ensure the drawings are suitable for your project. Weathertex accepts no liability in respect to the use of these drawings.



DRAWING NAME:  
CAVITY FIX INSTALLATION - METER BOX JAMB  
(SELFLOK RANGE)

SCALE:  
NTS

DRAWN BY:  
A.MOATE

CHECKED BY:  
R.STUART

DATE:  
02.09.22

DRAWING No.:  
NZ-PL-CF-16

SHT SIZE  
A4

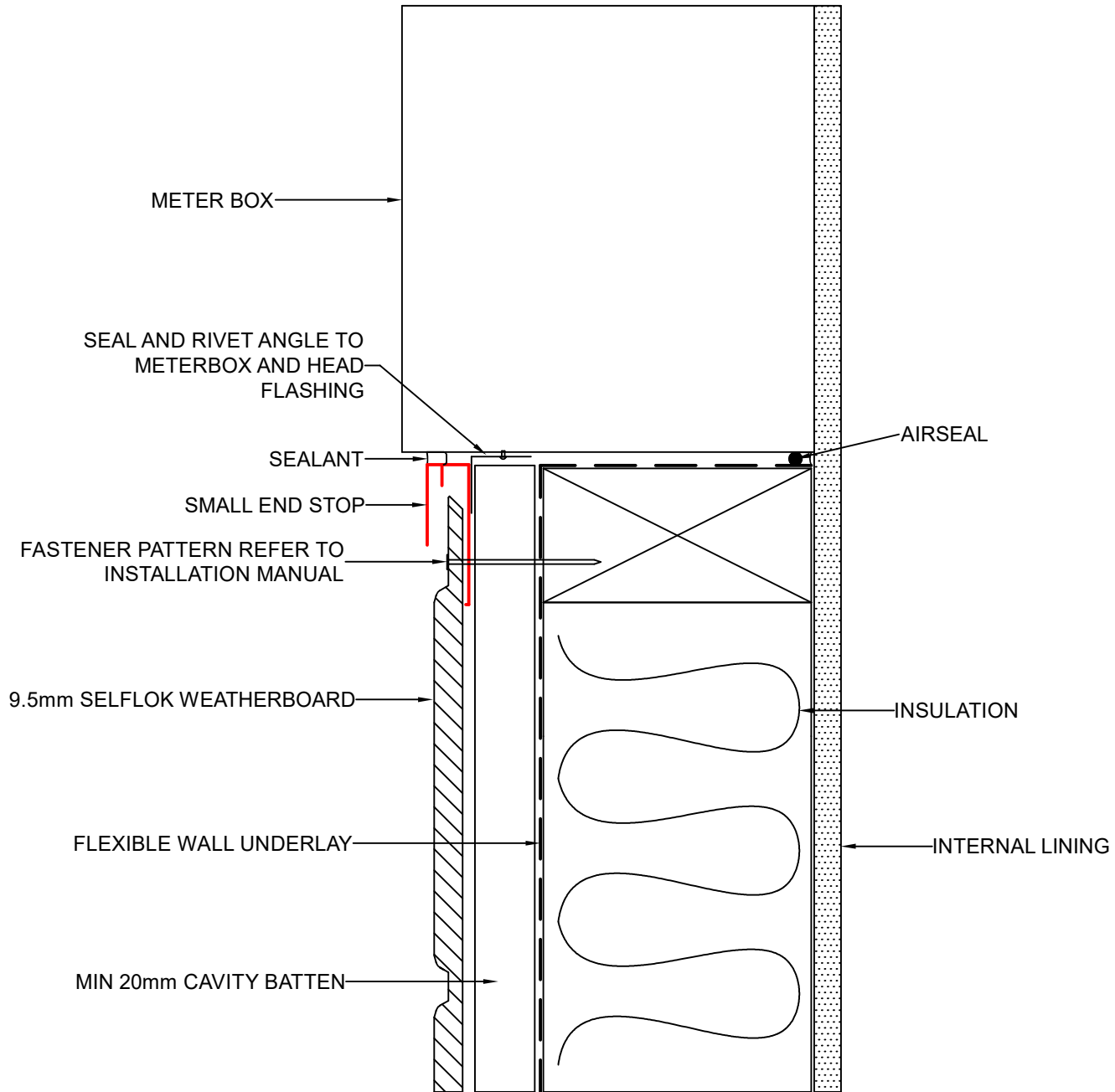

These drawings are for information only. They do not contain full details required for construction and must be used in conjunction with the current issue Weathertex Installation Manual, New Zealand Building Code and Local Regulations. Weathertex recommends gaining professional advice to ensure the drawings are suitable for your project. Weathertex accepts no liability in respect to the use of these drawings.



DRAWING NAME:  
CAVITY FIX INSTALLATION - METER BOX SILL  
(SELFLOK RANGE)

SCALE:

NTS

DRAWN BY:

A.MOATE

CHECKED BY:

R.STUART

DATE:

02.09.22

DRAWING No.:

NZ-SL-CF-17

SHT SIZE

A4

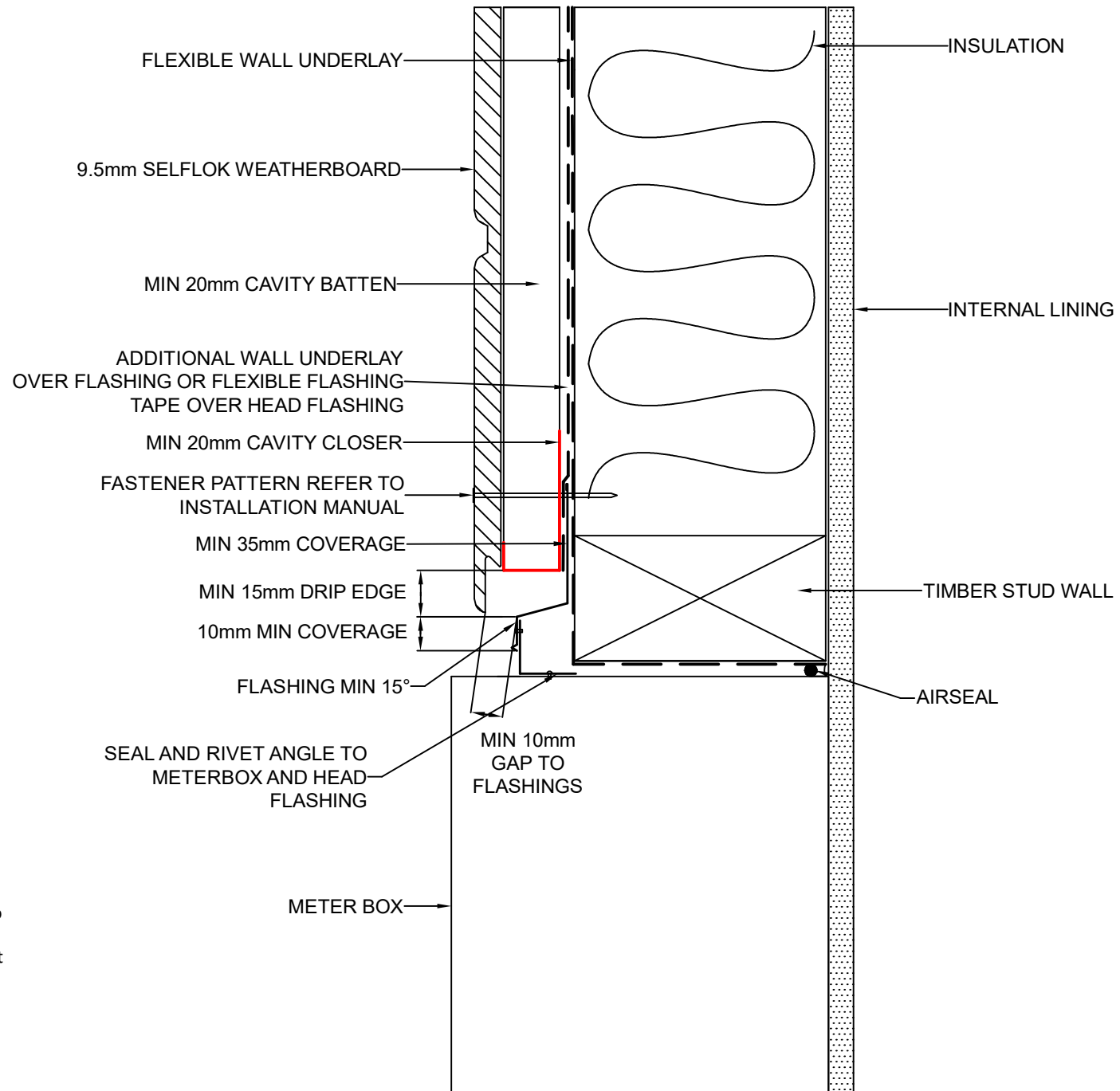

These drawings are for information only. They do not contain full details required for construction and must be used in conjunction with the current issue Weathertex Installation Manual, New Zealand Building Code and Local Regulations. Weathertex recommends gaining professional advice to ensure the drawings are suitable for your project. Weathertex accepts no liability in respect to the use of these drawings.



DRAWING NAME:  
 CAVITY FIX INSTALLATION - METER BOX HEAD  
 (SELFLOK RANGE)

SCALE:

NTS

DRAWN BY:

A.MOATE

CHECKED BY:

R.STUART

DATE:

02.09.22

DRAWING No.:

NZ-SL-CF-18

SHT SIZE

A4

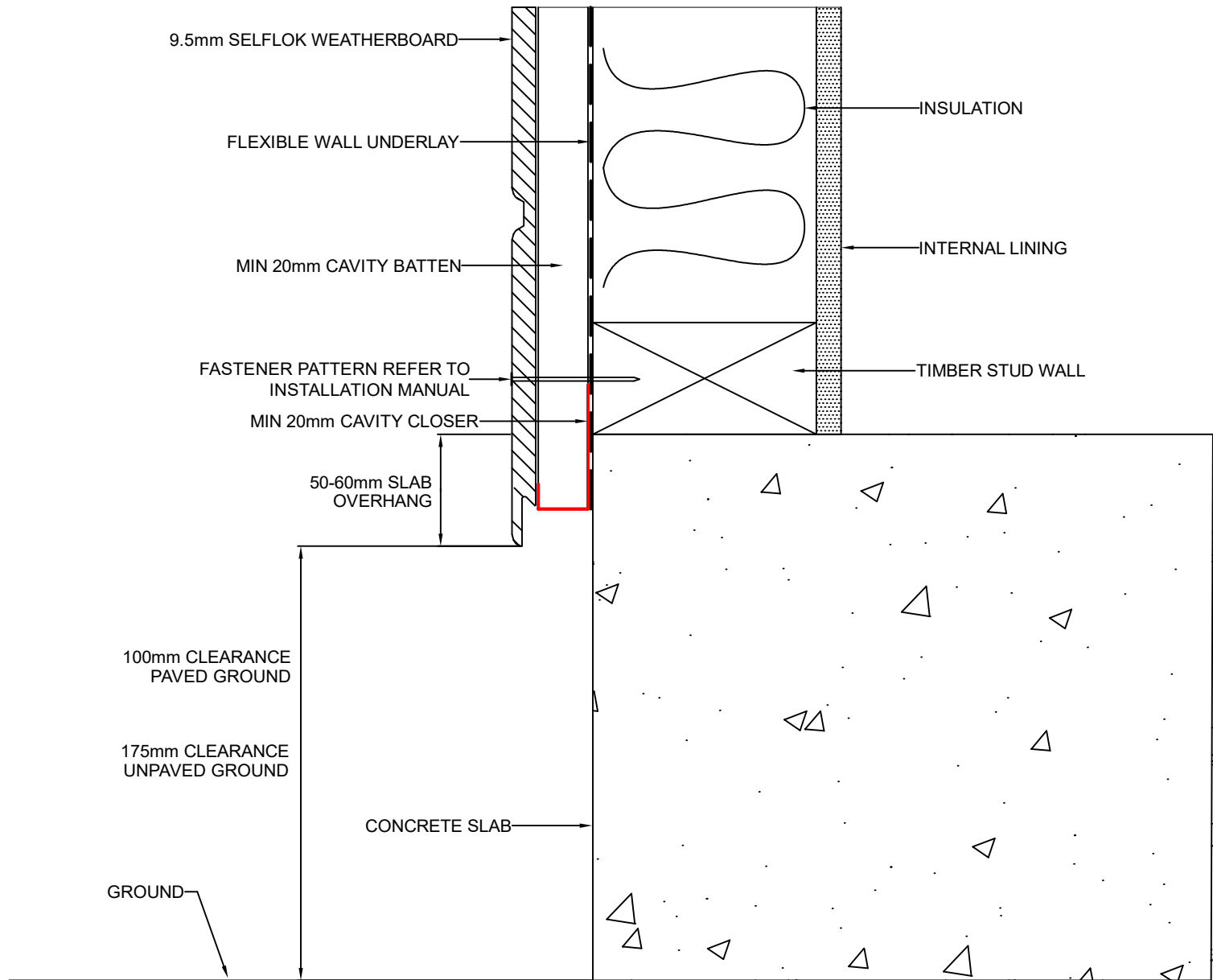

These drawings are for information only. They do not contain full details required for construction and must be used in conjunction with the current issue Weathertex Installation Manual, New Zealand Building Code and Local Regulations. Weathertex recommends gaining professional advice to ensure the drawings are suitable for your project. Weathertex accepts no liability in respect to the use of these drawings.

	DRAWING NAME: CAVITY FIX INSTALLATION - GROUND CLEARANCE (SELFLOK RANGE)	SCALE: NTS	DRAWN BY: A.MOATE	CHECKED BY: R.STUART	DATE: 02.09.22	DRAWING No.: NZ-SL-CF-19	SHT SIZE A4

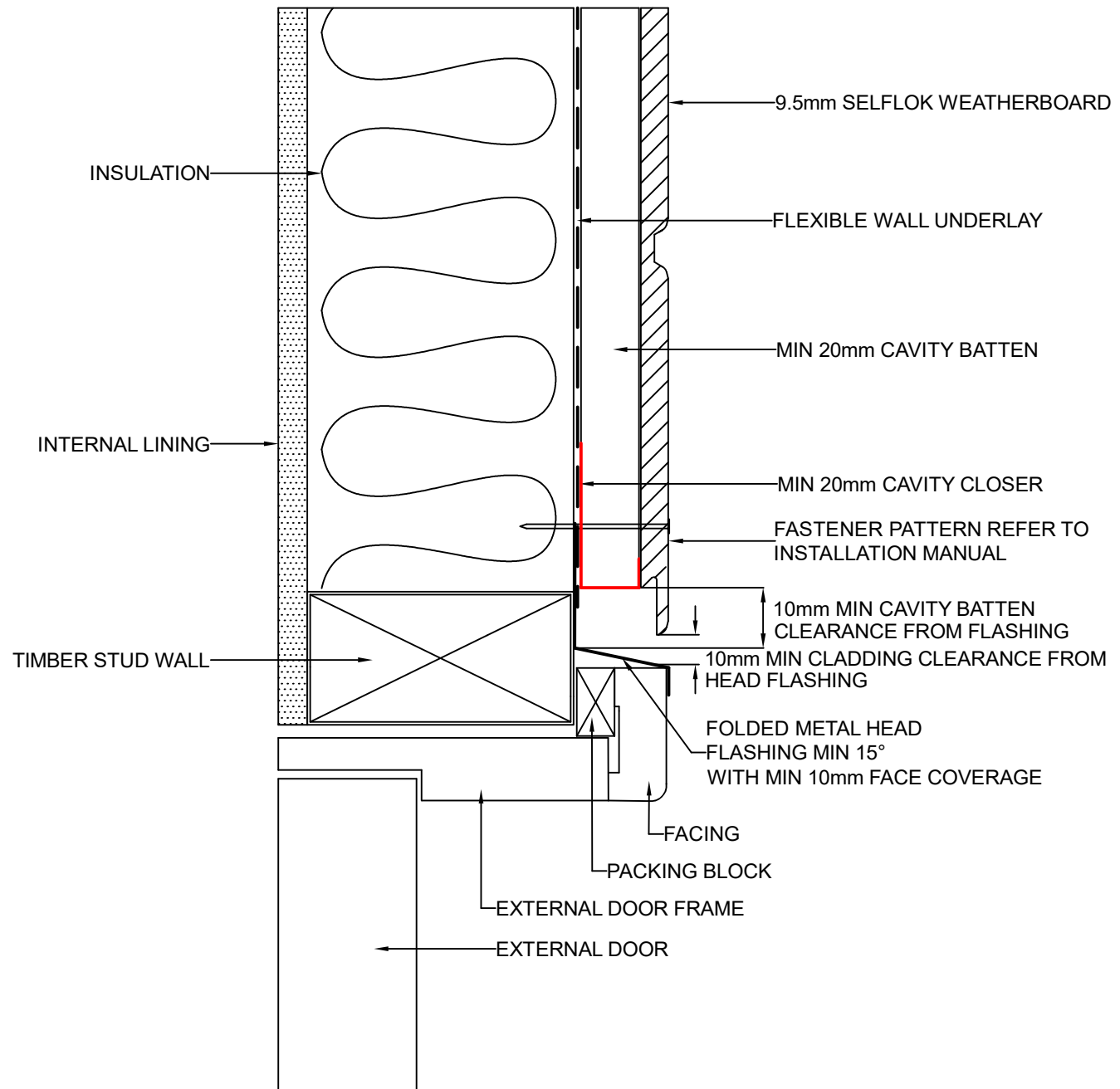

These drawings are for information only. They do not contain full details required for construction and must be used in conjunction with the current issue Weathertex Installation Manual, New Zealand Building Code and Local Regulations. Weathertex recommends gaining professional advice to ensure the drawings are suitable for your project. Weathertex accepts no liability in respect to the use of these drawings.



DRAWING NAME:  
CAVITY FIX INSTALLATION - DOOR HEAD  
(SELFLOK RANGE)

SCALE:  
NTS

DRAWN BY:  
A.MOATE

CHECKED BY:  
R.STUART

DATE:  
02.09.22

DRAWING No.:  
NZ-PL-CF-20

SHT SIZE  
A4

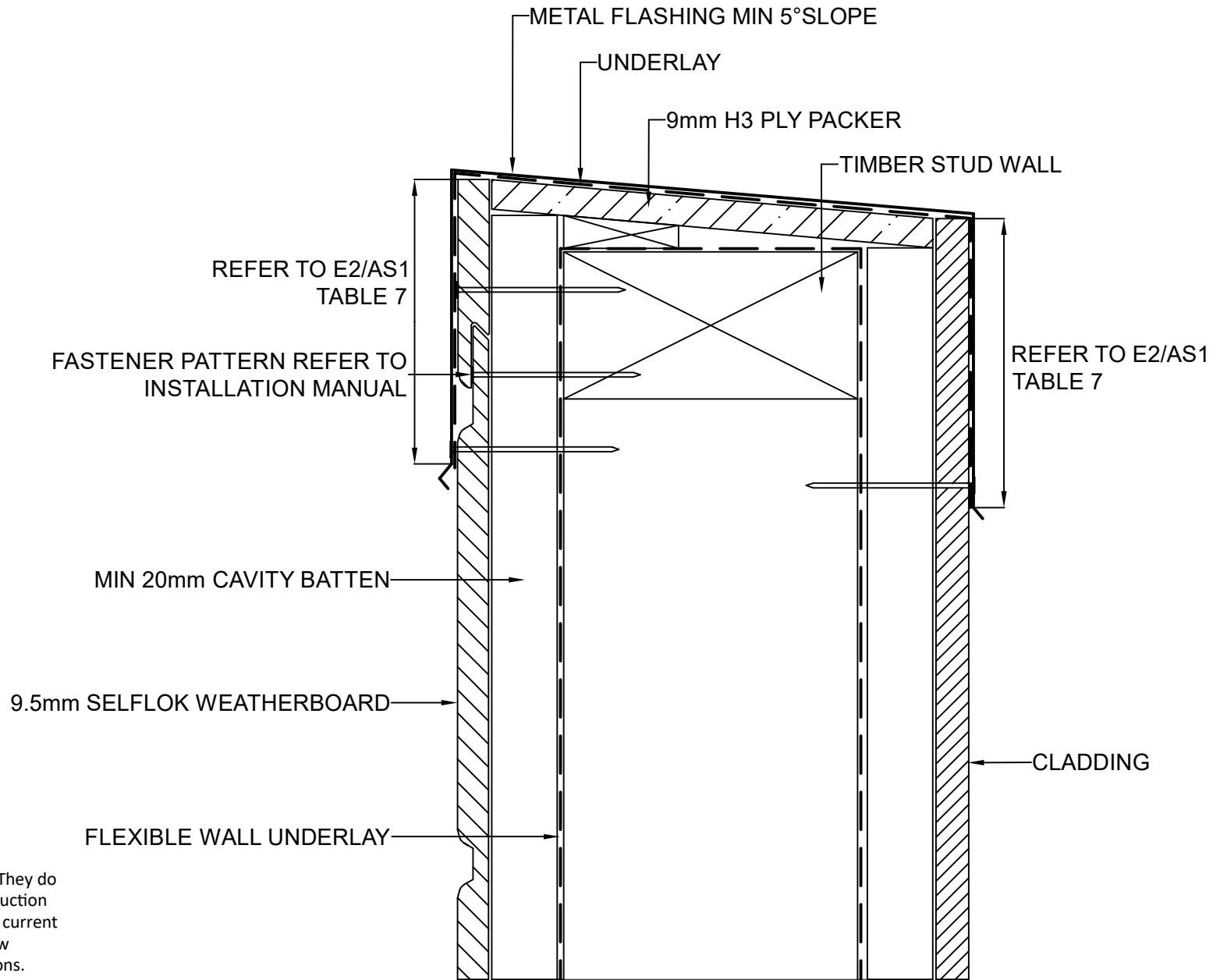

These drawings are for information only. They do not contain full details required for construction and must be used in conjunction with the current issue Weathertex Installation Manual, New Zealand Building Code and Local Regulations. Weathertex recommends gaining professional advice to ensure the drawings are suitable for your project. Weathertex accepts no liability in respect to the use of these drawings.

FOR BALUSTRADE/WALL JUNCTION  
REFER TO E2/AS1 FIG. 11 & 12



DRAWING NAME:  
CAVITY FIX INSTALLATION - PARAPET  
(SELFLOK RANGE)

SCALE:  
NTS

DRAWN BY:  
A.MOATE

CHECKED BY:  
R.STUART

DATE:  
02.09.22

DRAWING No.:  
NZ-SL-CF-21

SHT SIZE  
A4

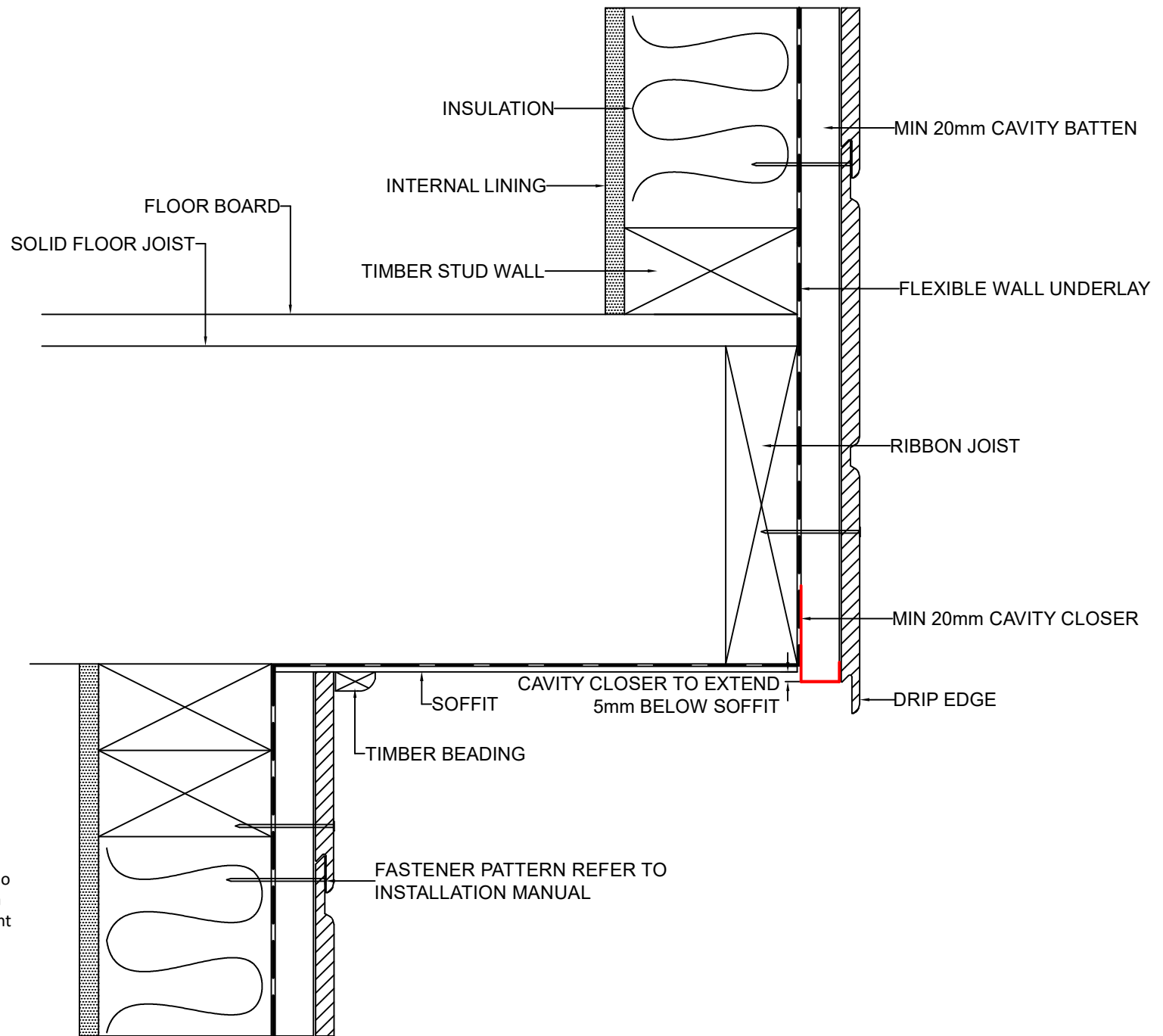

These drawings are for information only. They do not contain full details required for construction and must be used in conjunction with the current issue Weathertex Installation Manual, New Zealand Building Code and Local Regulations. Weathertex recommends gaining professional advice to ensure the drawings are suitable for your project. Weathertex accepts no liability in respect to the use of these drawings.



DRAWING NAME:  
CAVITY FIX INSTALLATION - CANTILEVER ROOF  
(SELFLOK RANGE)

SCALE:  
NTS

DRAWN BY:  
A.MOATE

CHECKED BY:  
R.STUART

DATE:  
02.09.22

DRAWING No.:  
NZ-SL-CF-22

SHT SIZE  
A4

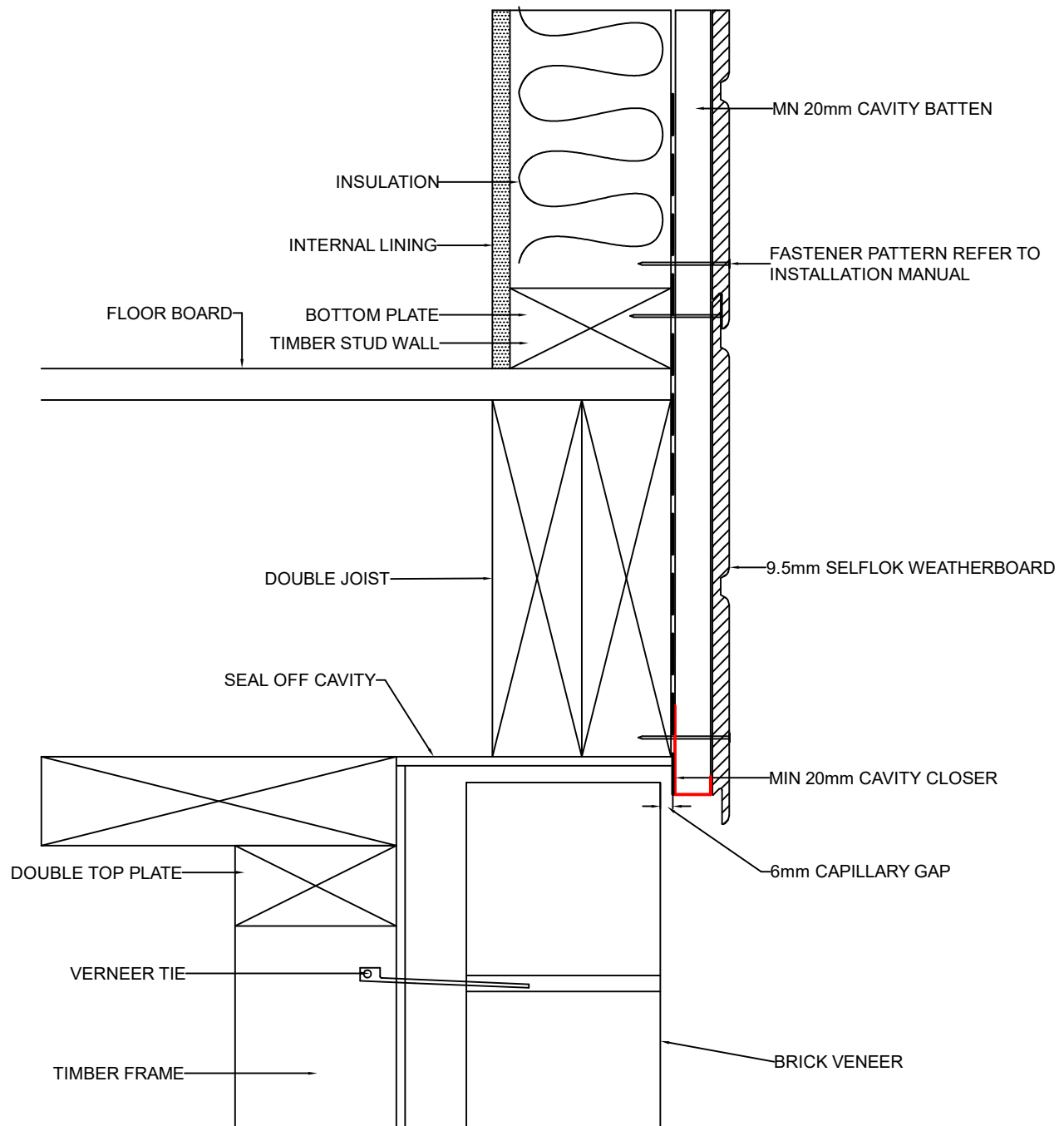

These drawings are for information only. They do not contain full details required for construction and must be used in conjunction with the current issue Weathertex Installation Manual, New Zealand Building Code and Local Regulations. Weathertex recommends gaining professional advice to ensure the drawings are suitable for your project. Weathertex accepts no liability in respect to the use of these drawings.



DRAWING NAME:  
CAVITY FIX INSTALLATION - FLUSH WITH VENEER  
(SELFLOK RANGE)

SCALE:

NTS

DRAWN BY:

A.MOATE

CHECKED BY:

R.STUART

DATE:

02.09.22

DRAWING No.:

NZ-SL-CF-23

SHT SIZE

A4



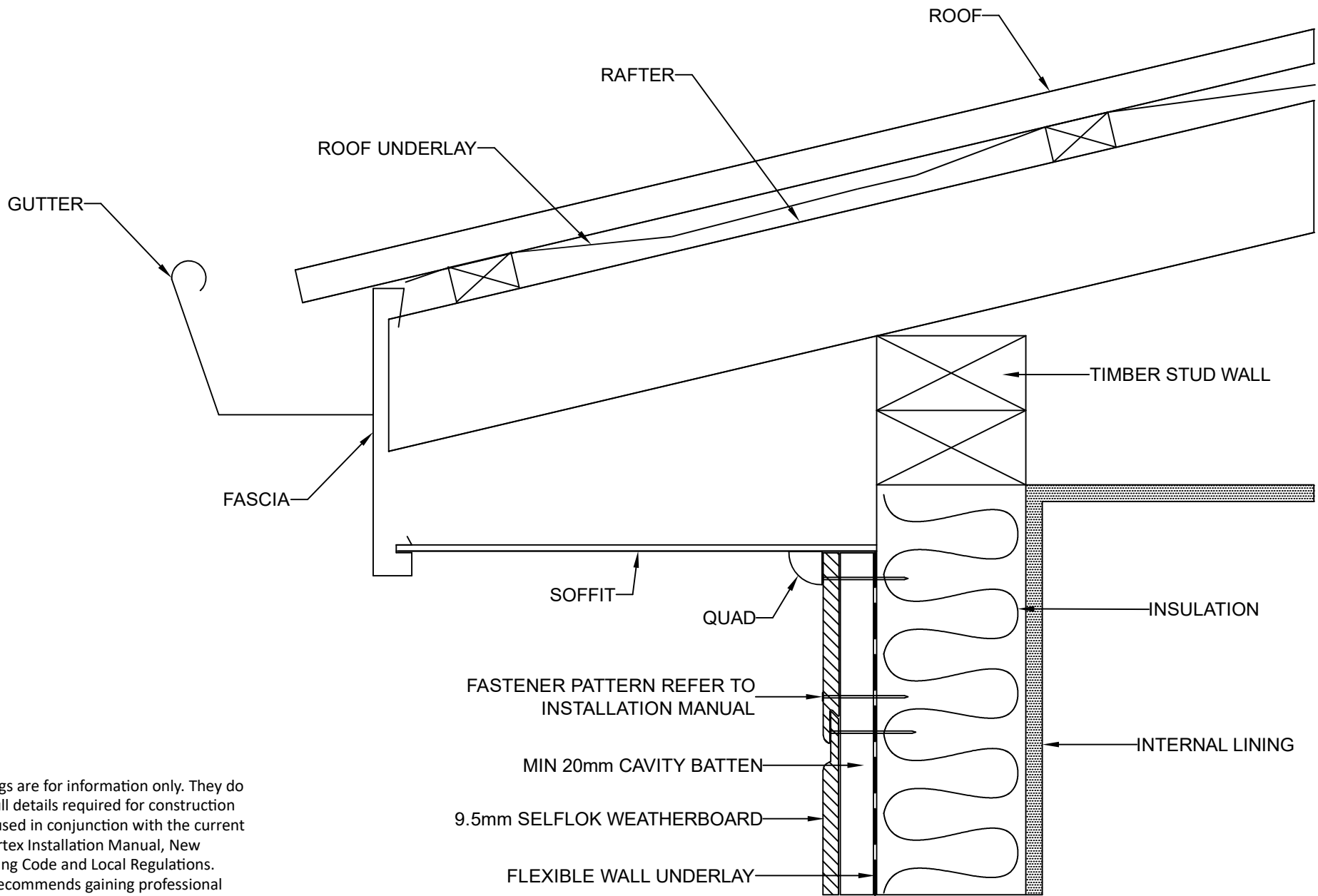

These drawings are for information only. They do not contain full details required for construction and must be used in conjunction with the current issue Weathertex Installation Manual, New Zealand Building Code and Local Regulations. Weathertex recommends gaining professional advice to ensure the drawings are suitable for your project. Weathertex accepts no liability in respect to the use of these drawings.

	DRAWING NAME: CAVITY FIX INSTALLATION - SOFFIT (SELFLOK RANGE)	SCALE: NTS	DRAWN BY: A.MOATE	CHECKED BY: R.STUART	DATE: 02.09.22	DRAWING No.: NZ-SL-CF-24	SHT SIZE A4

These drawings are for information only. They do not contain full details required for construction and must be used in conjunction with the current issue Weathertex Installation Manual, New Zealand Building Code and Local Regulations. Weathertex recommends gaining professional advice to ensure the drawings are suitable for your project. Weathertex accepts no liability in respect to the use of these drawings.

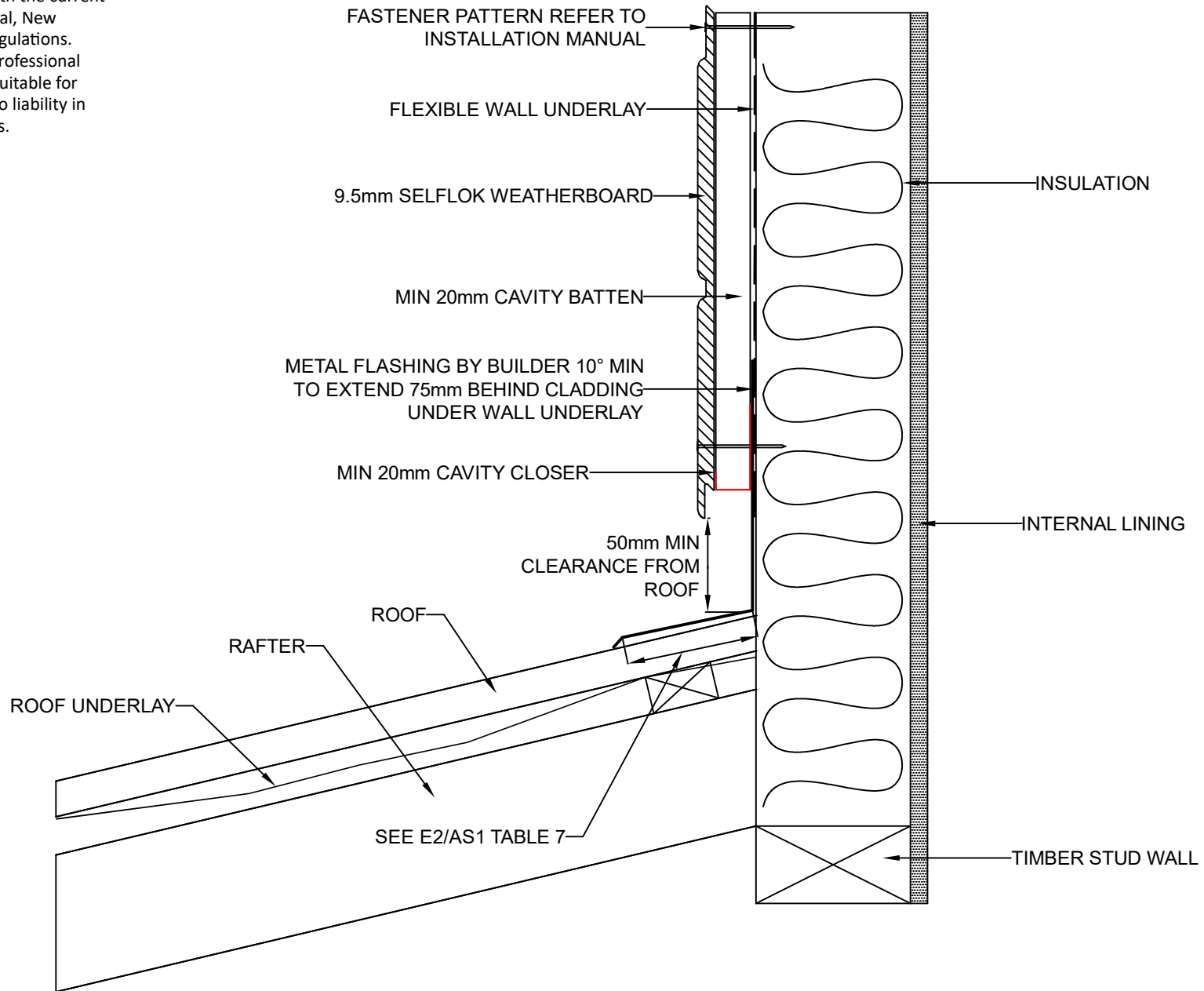

DRAWING NAME:  
CAVITY FIX INSTALLATION - ROOF CLEARANCE  
(SELFLOK RANGE)

SCALE:  
NTS

DRAWN BY:  
A.MOATE

CHECKED BY:  
R.STUART

DATE:  
02.09.22

DRAWING No.:  
NZ-SL-CF-25

SHT SIZE  
A4

These drawings are for information only. They do not contain full details required for construction and must be used in conjunction with the current issue Weathertex Installation Manual, New Zealand Building Code and Local Regulations. Weathertex recommends gaining professional advice to ensure the drawings are suitable for your project. Weathertex accepts no liability in respect to the use of these drawings.

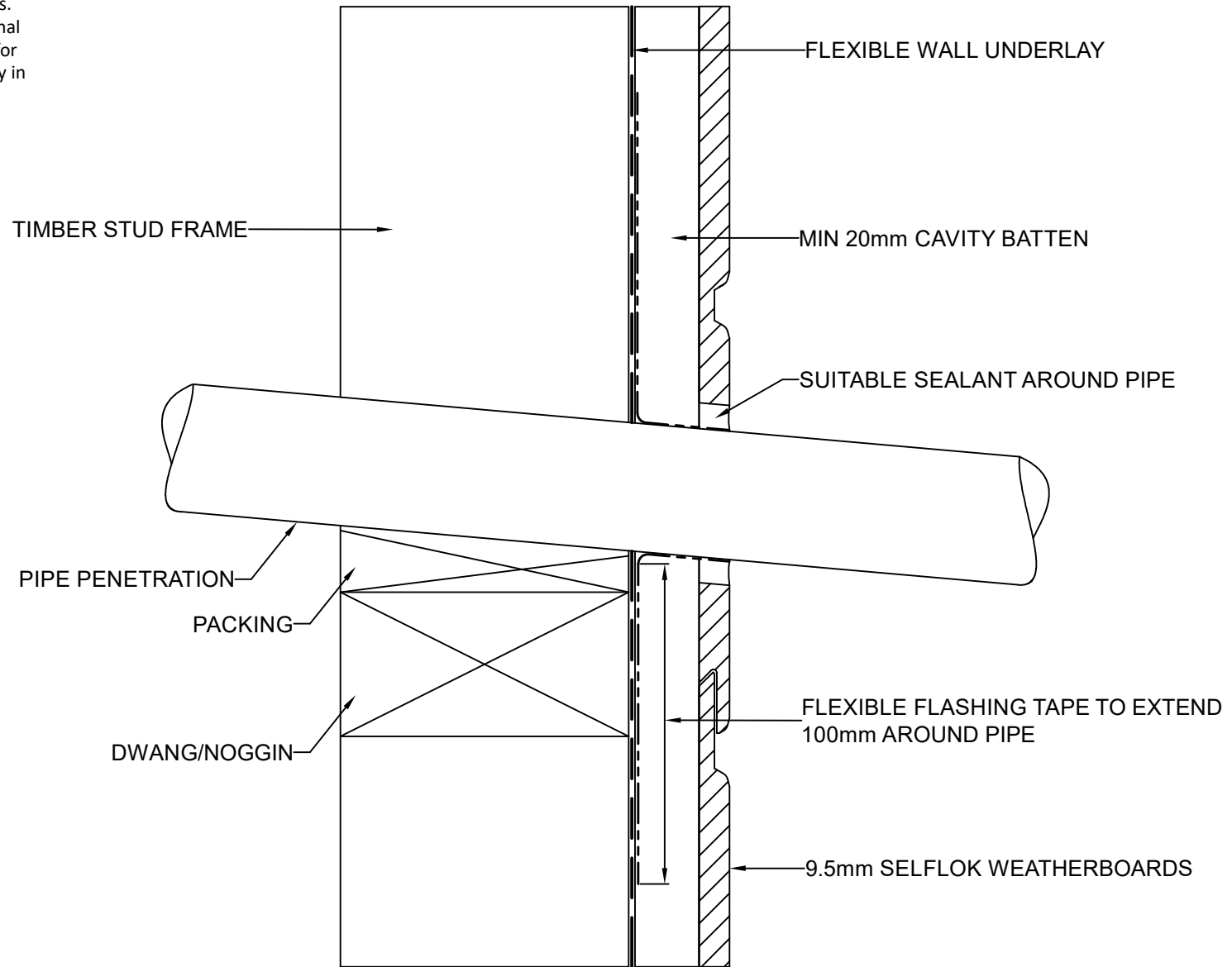

These drawings are for information only. They do not contain full details required for construction and must be used in conjunction with the current issue Weathertex Installation Manual, New Zealand Building Code and Local Regulations. Weathertex recommends gaining professional advice to ensure the drawings are suitable for your project. Weathertex accepts no liability in respect to the use of these drawings.

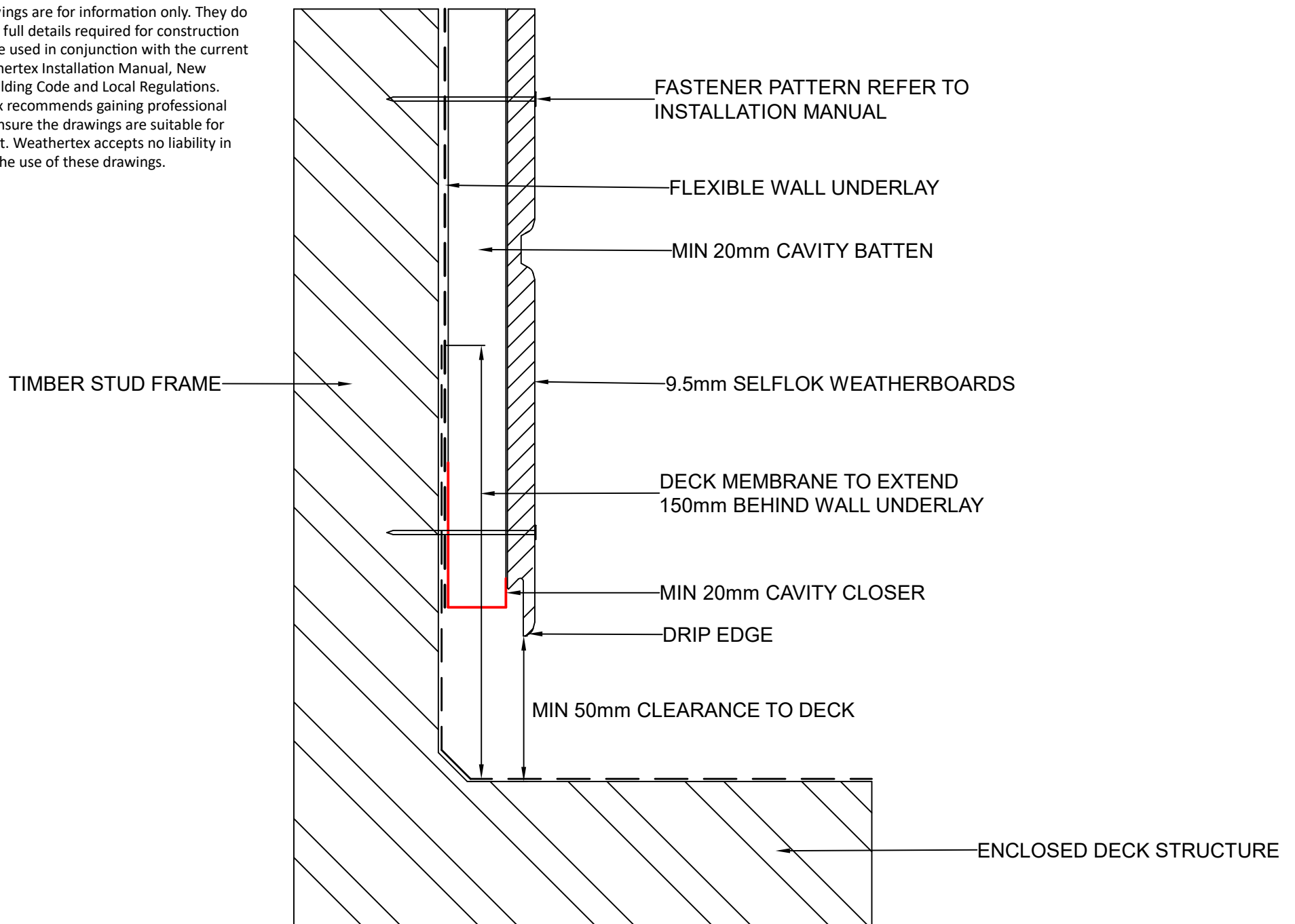

DRAWING NAME:  
CAVITY FIX INSTALLATION - MEMBRANE DECK  
(SELFLOK RANGE)

SCALE:  
NTS

DRAWN BY:  
A.MOATE

CHECKED BY:  
R.STUART

DATE:  
02.09.22

DRAWING No.:  
NZ-SL-CF-27

SHT SIZE  
A4

These drawings are for information only. They do not contain full details required for construction and must be used in conjunction with the current issue Weathertex Installation Manual, New Zealand Building Code and Local Regulations. Weathertex recommends gaining professional advice to ensure the drawings are suitable for your project. Weathertex accepts no liability in respect to the use of these drawings.

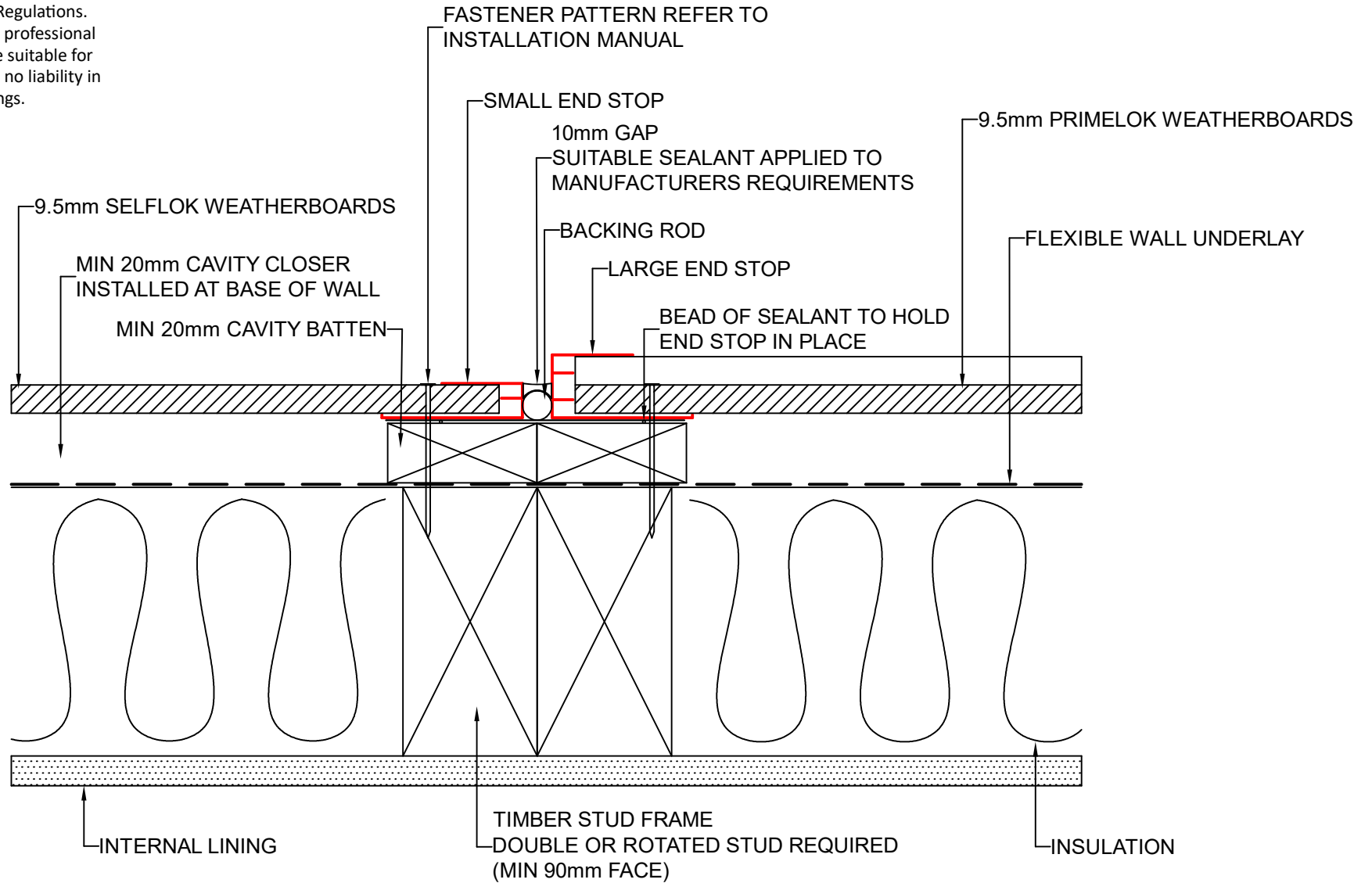

DRAWING NAME:  
CAVITY FIX INSTALLATION - BACK TO BACK END STOP  
(SELFLOK RANGE)

SCALE:  
NTS

DRAWN BY:  
A.MOATE

CHECKED BY:  
R.STUART

DATE:  
02.09.22

DRAWING No.:  
NZ-SL-CF-28

SHT SIZE  
A4

These drawings are for information only. They do not contain full details required for construction and must be used in conjunction with the current issue Weathertex Installation Manual, New Zealand Building Code and Local Regulations. Weathertex recommends gaining professional advice to ensure the drawings are suitable for your project. Weathertex accepts no liability in respect to the use of these drawings.

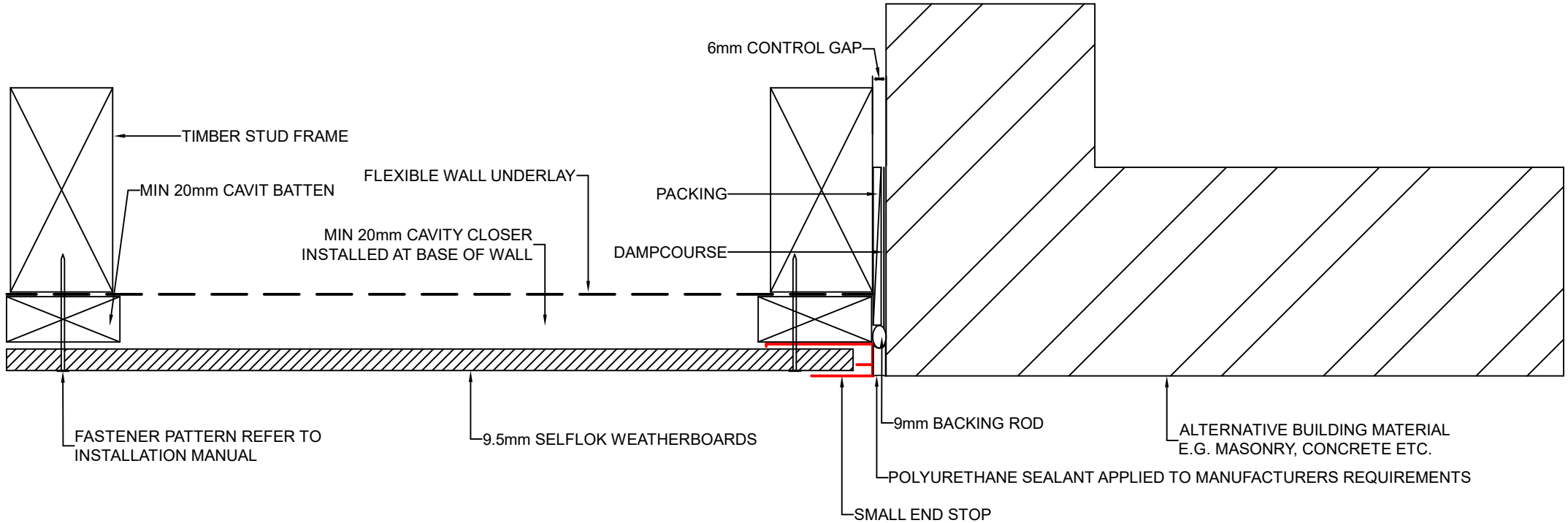

DRAWING NAME:  
CAVITY FIX INSTALLATION - END STOP TO ALTERNATIVE MATERIALS  
(SELFLOK RANGE)

SCALE:  
NTS

DRAWN BY:  
A.MOATE

CHECKED BY:  
R.STUART

DATE:  
02.09.22

DRAWING No.:  
NZ-SL-CF-29

SHT SIZE  
A4

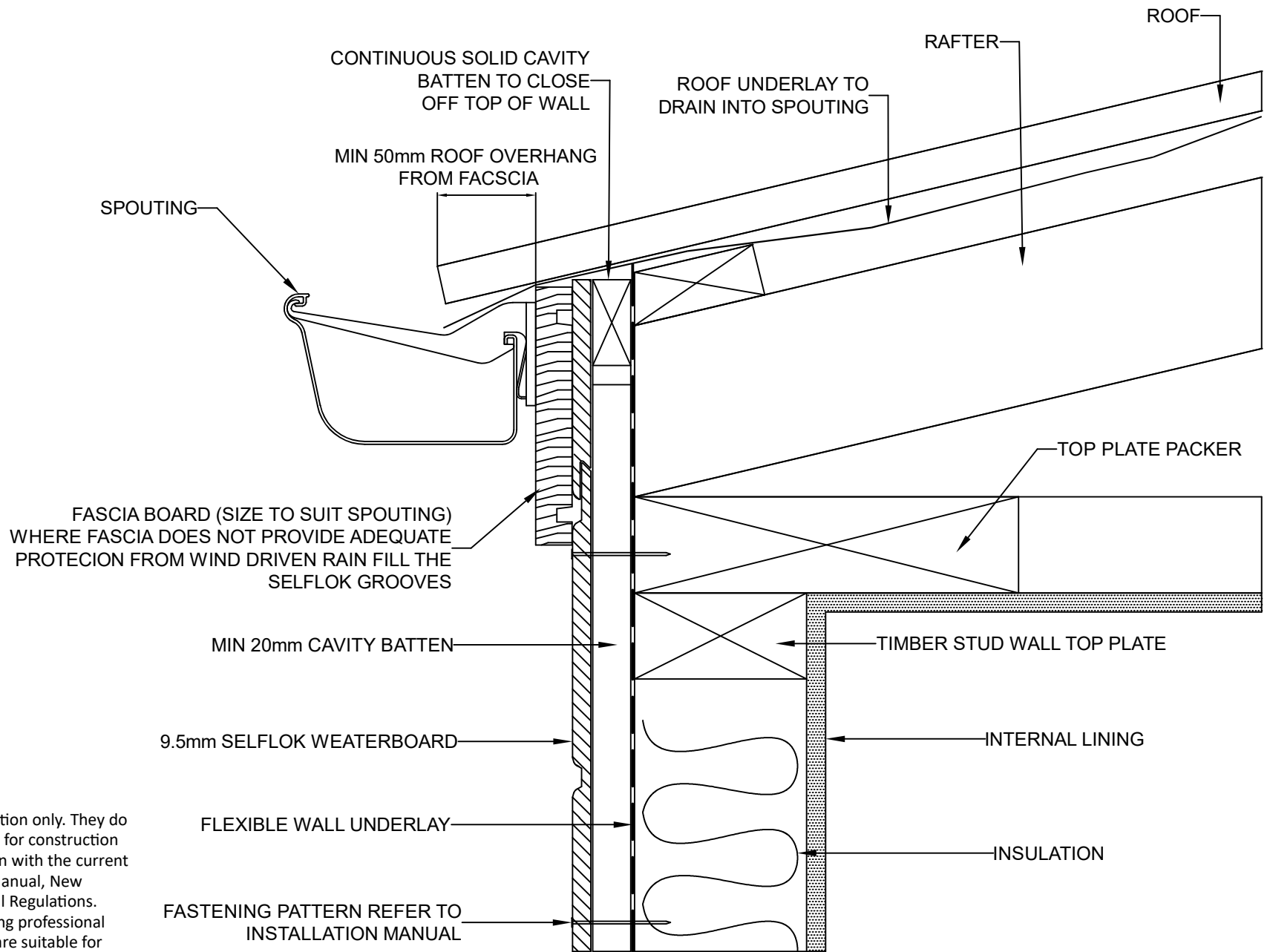

These drawings are for information only. They do not contain full details required for construction and must be used in conjunction with the current issue Weathertex Installation Manual, New Zealand Building Code and Local Regulations. Weathertex recommends gaining professional advice to ensure the drawings are suitable for your project. Weathertex accepts no liability in respect to the use of these drawings.



DRAWING NAME:  
CAVITY FIX INSTALLATION - NO SOFFIT  
(SELFLOK RANGE)

SCALE:

NTS

DRAWN BY:

A.MOATE

CHECKED BY:

R.STUART

DATE:

29.11.22

DRAWING No.:

NZ-SL-CF-30

SHT SIZE

A4