



Profile Guide



Look for our FSC®
products on our
website
www.ititimspec.nz



Supplying only the very best timbers from NZ and around the world...



Accoya black cladding, Location: Red Beach, Auckland
Arcreate Design



Western Red Cedar Fins, Location: Auckland
Studio 2 Architects

Contents

Exterior Profiles

Page

1. CertClad Weatherboards	
1.1 Bevelback Weatherboards.....	3
1.2 Rusticated Weatherboards.....	7
1.3 Vertical Shiplap Weatherboards.....	12
2. Mouldings.....	17
3. Fascia.....	19
4. Dressed Four Sides (D4S).....	21
5. Decking	
5.1 CertDeck Timber Decking Profiles.....	24
5.2 Eva-Last Composite.....	28

Interior Profiles

6. Interior Mouldings - EziTrimPlus.....	29
7. Paneling, Sarking & Soffit Linings.....	33
8. CertFloor Flooring	
8.1 Engineered Flooring - T&G.....	35
8.2 Solid Hardwood Flooring - T&G.....	38

1. CertClad Weatherboards

1.1 Bevelback Profiles

Note: Available in Accoya, Western Red Cedar and Radiata Pine
Accoya is acetylated NZ Radiata Pine produced by Accsys Technologies,
Netherlands
Only paint is recommended for Radiata Pine.



Horizontal - Bevelback Weatherboard Profiles

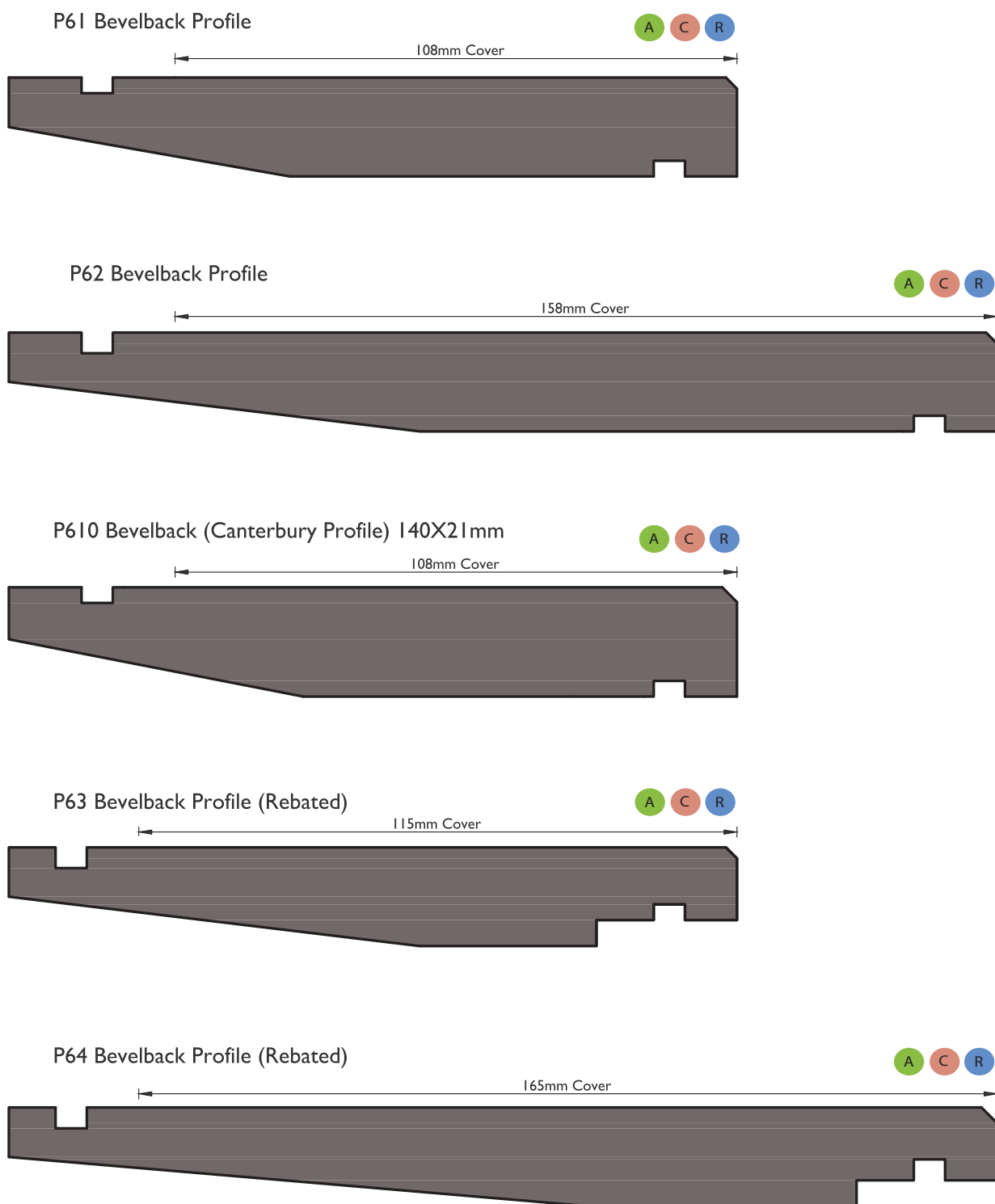

A ACCOYA®
19mm thick

C WESTERN RED CEDAR
18.5mm thick

R RADIATA PINE
19mm thick

Horizontal - Bevelback Weatherboard Profiles

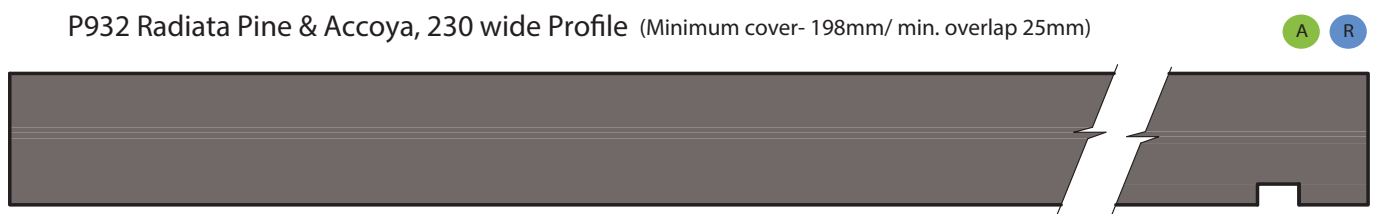
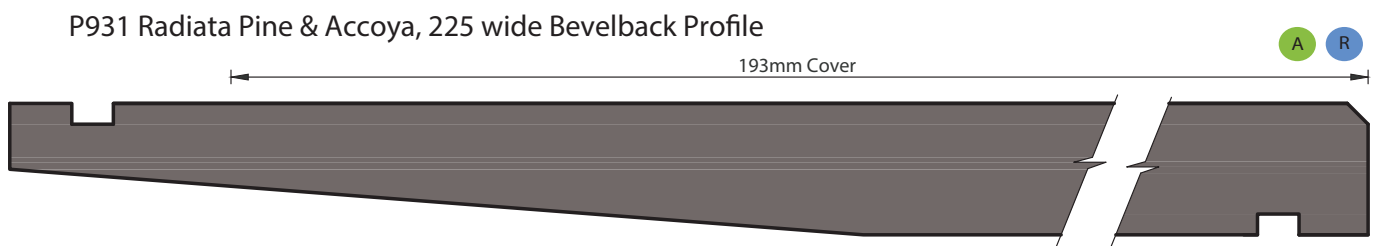
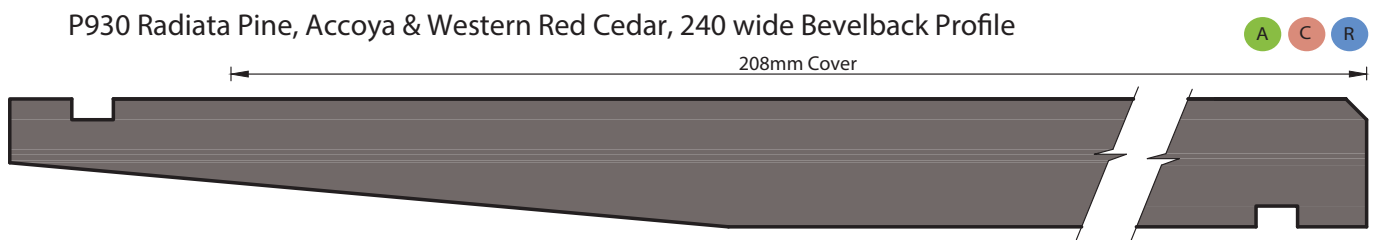
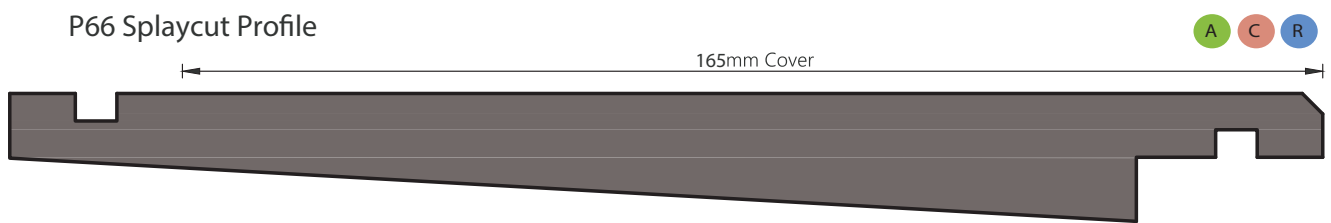
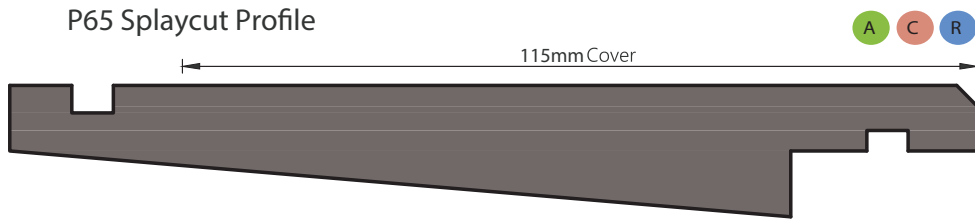

A ACCOYA®
19mm thick

C WESTERN RED CEDAR
18.5mm thick

R RADIATA PINE
19mm thick

Paint and Stain Profile

Bevelback Profiles

(a) Profile types with sharp corners are not suitable for paint, use stain only.

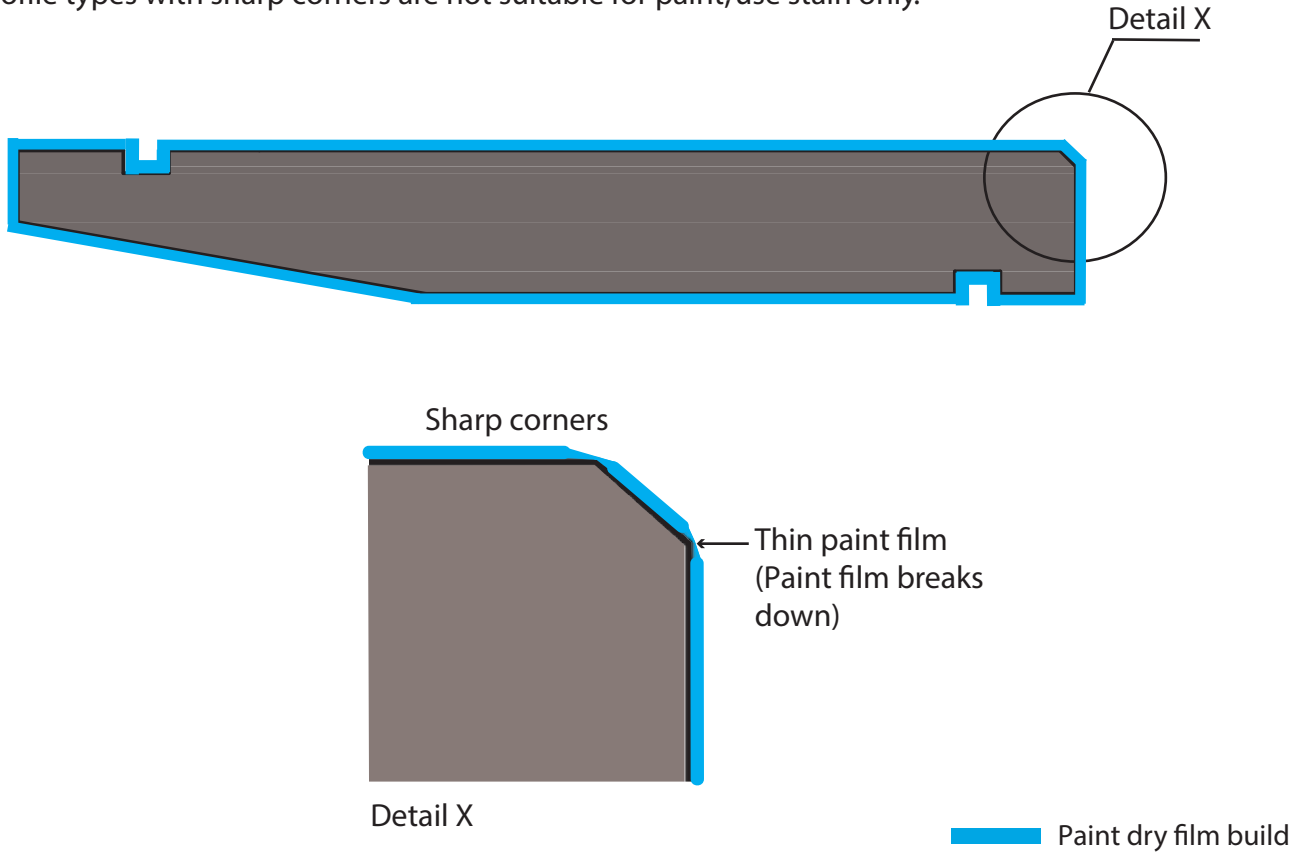

(b) Profile types with radiused corners are suitable for paint or stain

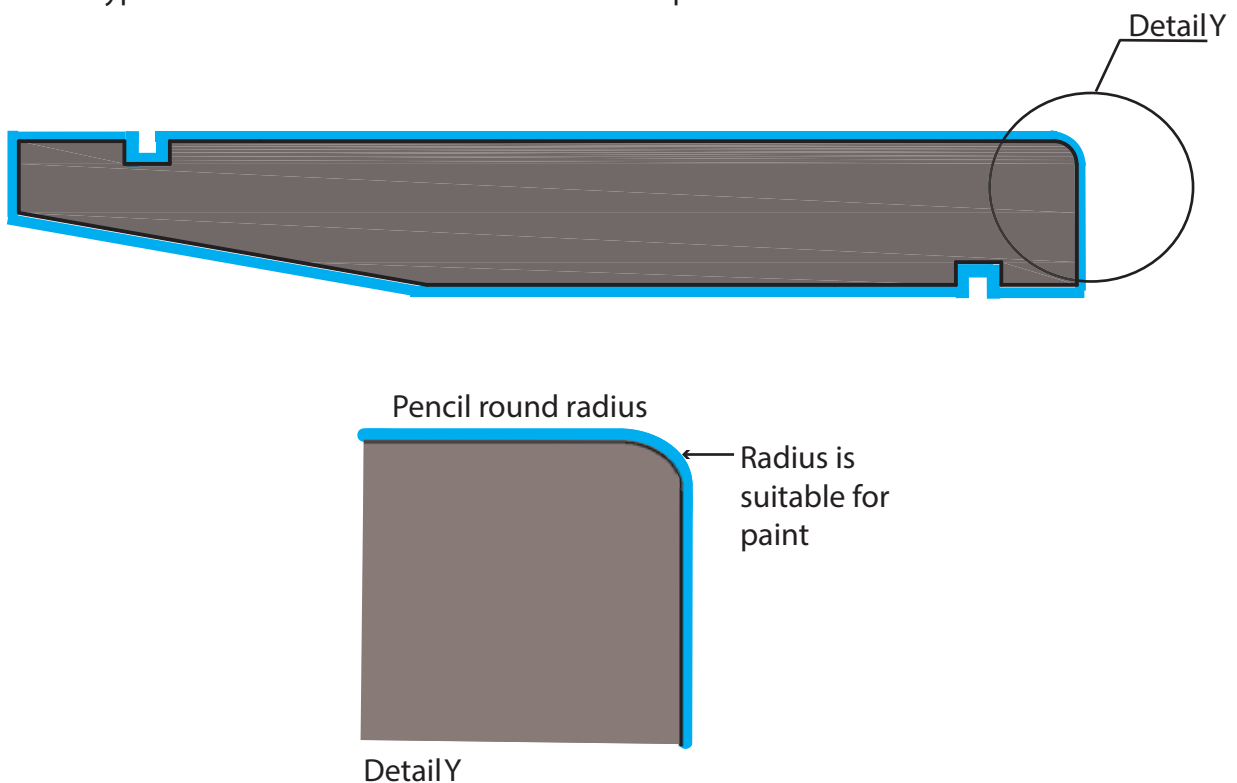

1. CertClad Weatherboards

1.2 Rusticated Profiles

Note: Available in Accoya, Western Red Cedar and Radiata Pine
Accoya is acetylated NZ Radiata Pine produced by Accsys Technologies,
Netherlands
Only paint is recommended for Radiata Pine.



Horizontal - Rusticated Weatherboard Profiles

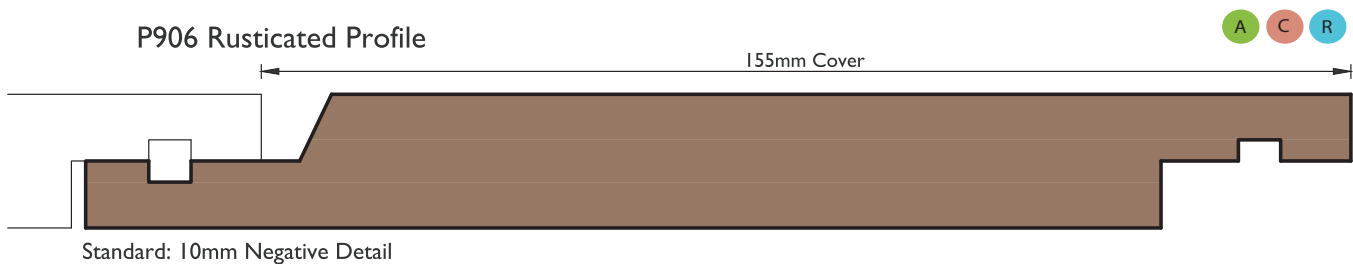
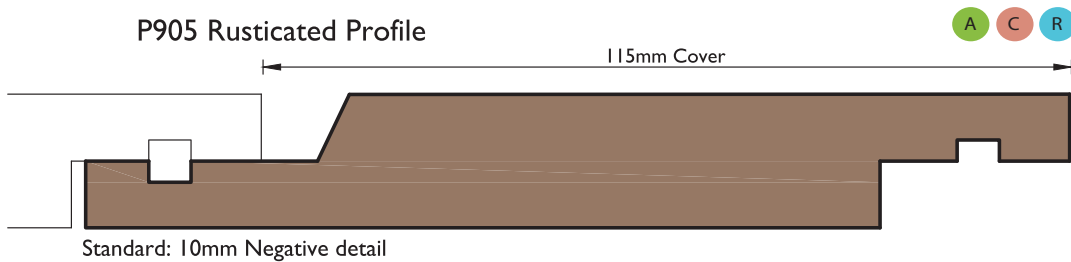
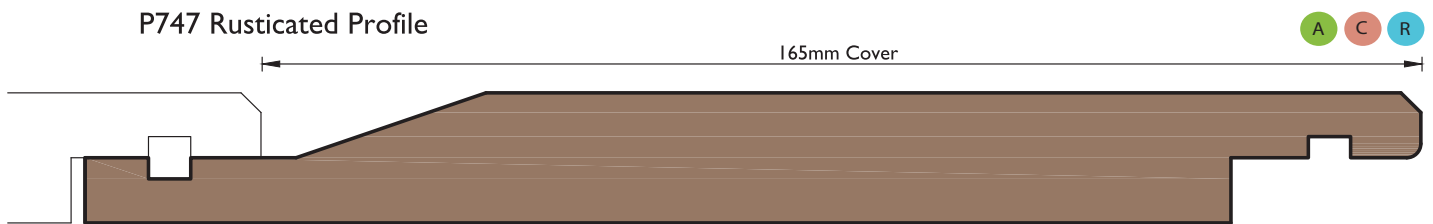
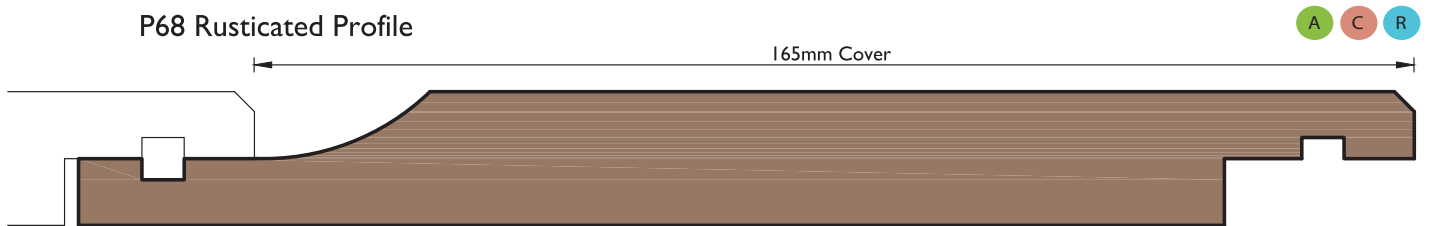
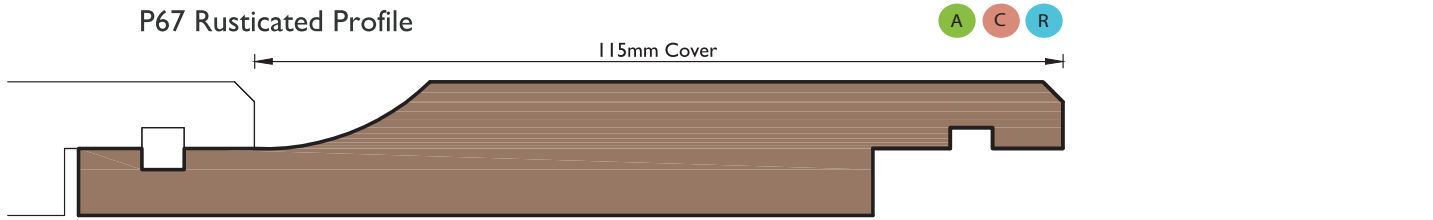

A ACCOYA®
19mm thick

C WESTERN RED CEDAR
18.5mm thick

R RADIATA PINE
19mm thick

Horizontal - Rusticated Weatherboard Profiles

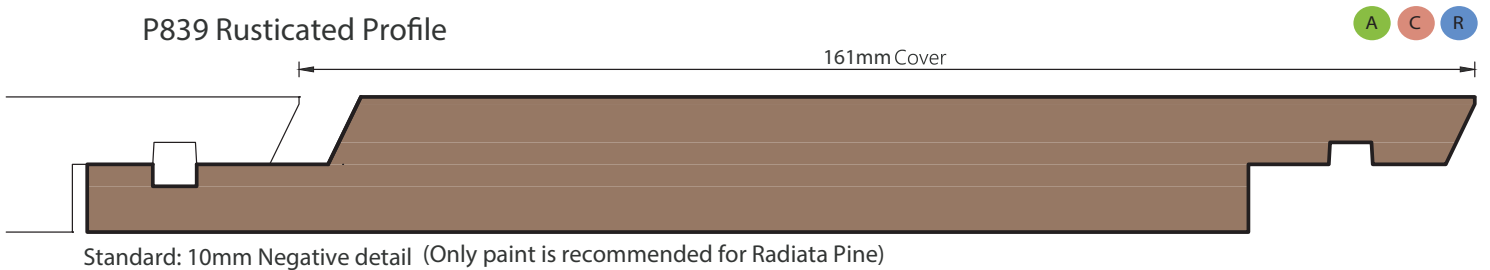
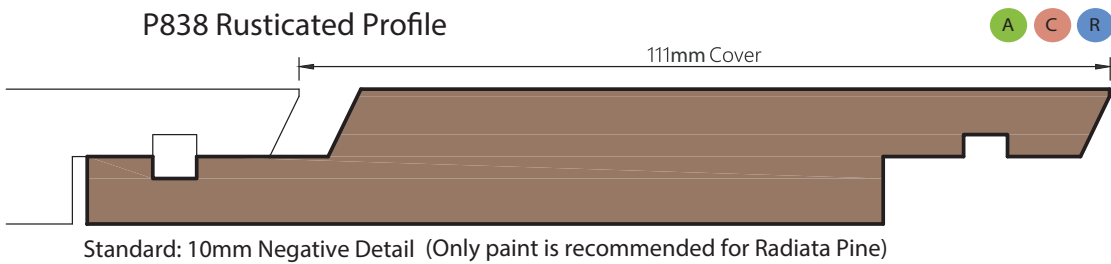
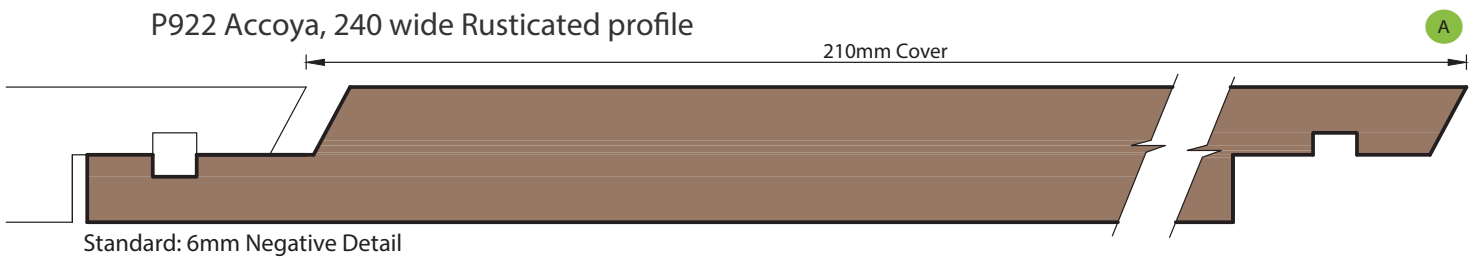
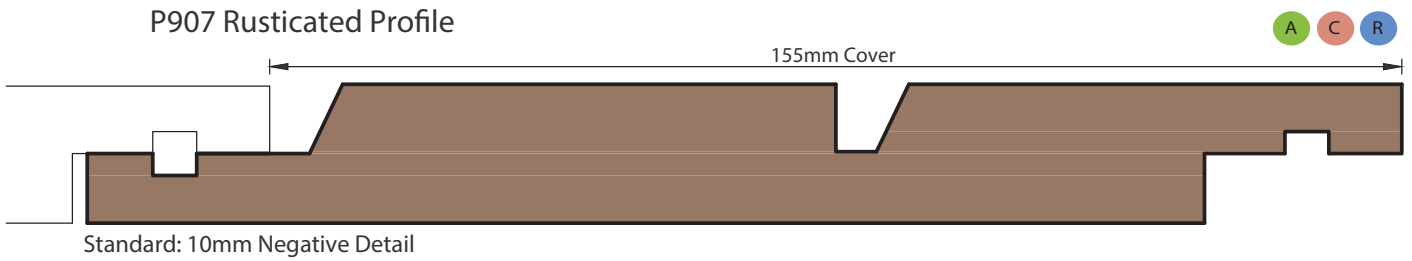

A ACCOYA®
19mm thick

C WESTERN RED CEDAR
18.5mm thick

R RADIATA PINE
19mm thick

Horizontal - Rusticated Random Width & Depth

Random Width & Depth (Combination Rusticated Profile)

A C

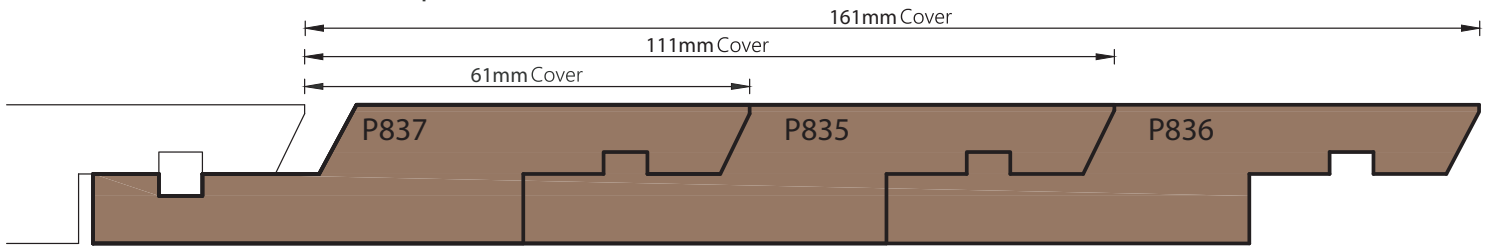

Standard: 6mm Negative detail (Accoya and WR Cedar available)

Random Width & Depth (Combination Rusticated Profile)

A C

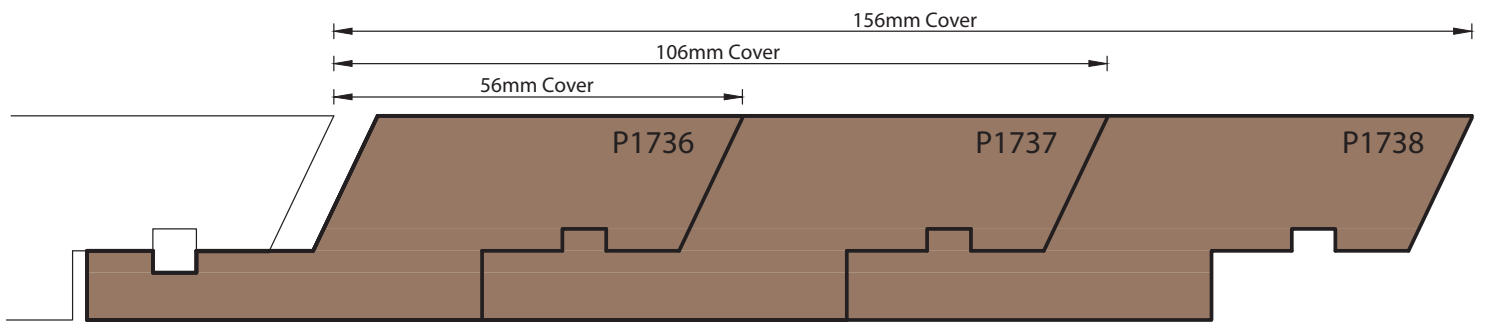

Standard: 6mm Negative detail (Accoya and WR Cedar available)

A ACCOYA®
19mm thick

C WESTERN RED CEDAR
18.5mm thick

R RADIATA PINE
19mm thick

Paint and Stain Profile

Rusticated Profiles

(a) Profile types with sharp corners are not suitable for paint, use stain only.

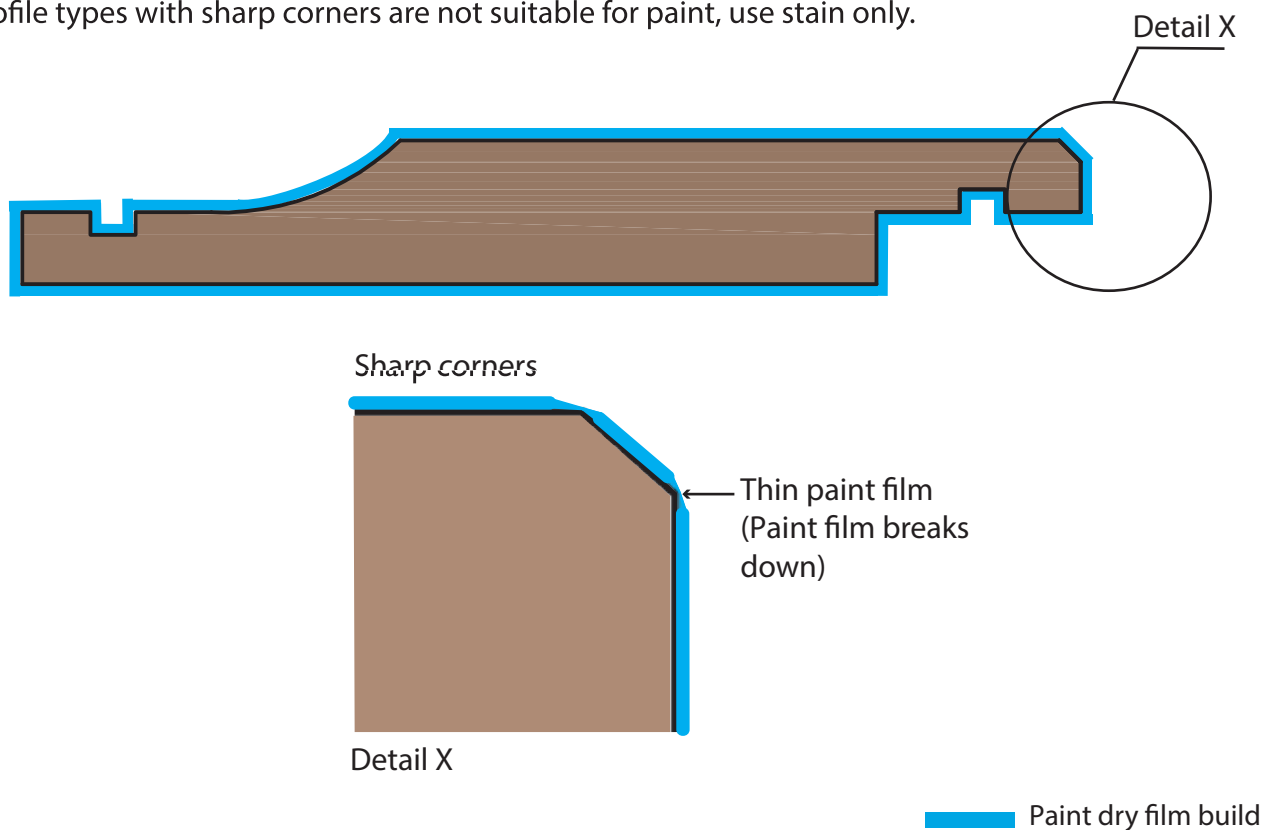

(b) Profile types with radiused corners are suitable for paint or stain.

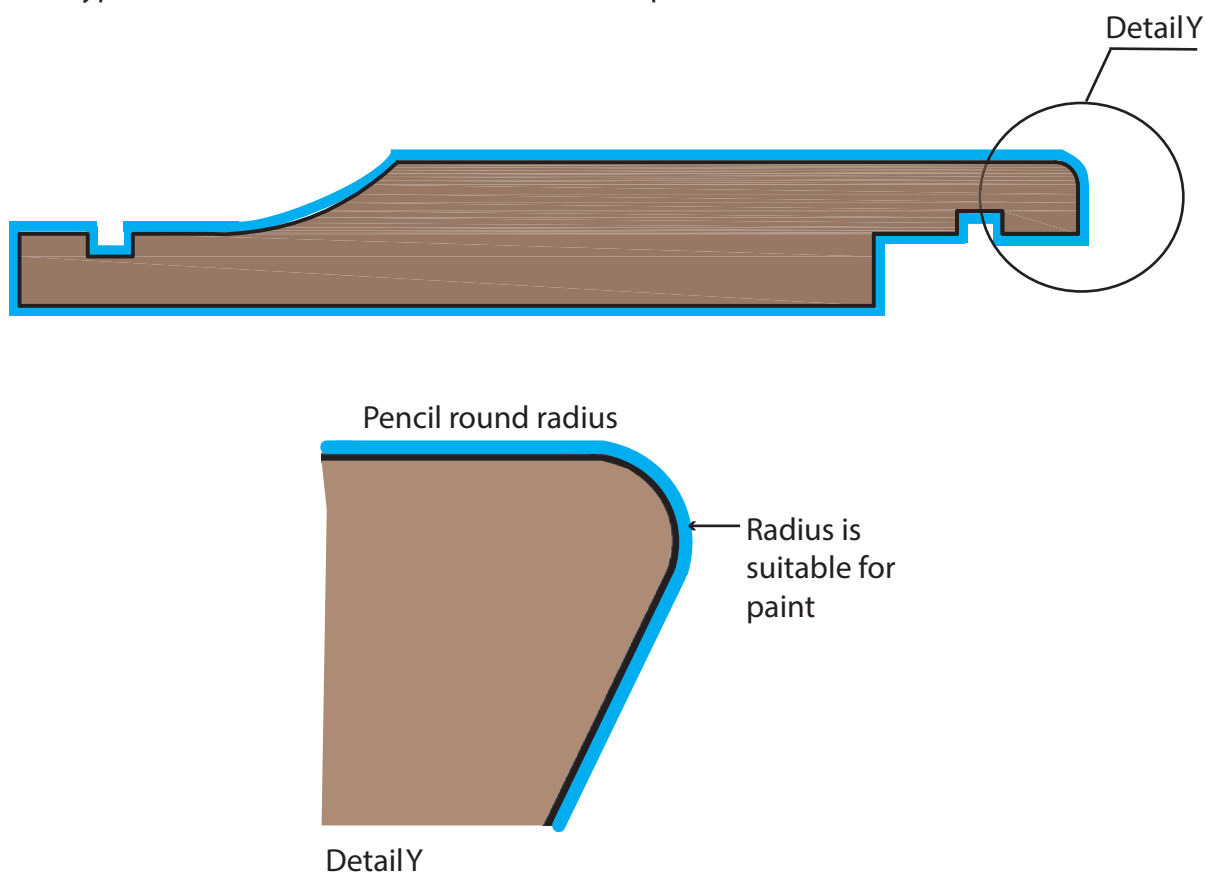

1. CertClad Weatherboards

1.3 Vertical Shiplap Profiles

Note: Available in Accoya, Western Red Cedar and Radiata Pine
Accoya is acetylated NZ Radiata Pine produced by Accsys Technologies,
Netherlands
Only paint is recommended for Radiata Pine.



Vertical - Shiplap Weatherboards

P51 Bevel Grooved Vertical Shiplap Profile

A C R

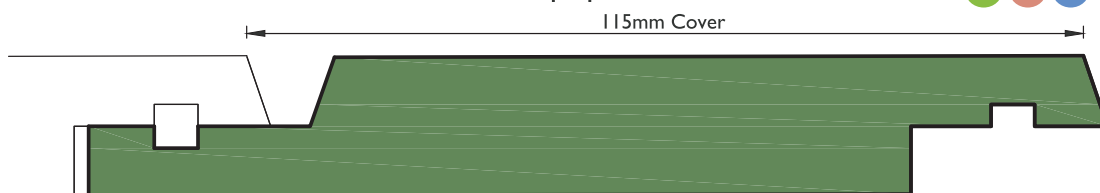

P52 Bevel Grooved Vertical Shiplap Profile

A C R

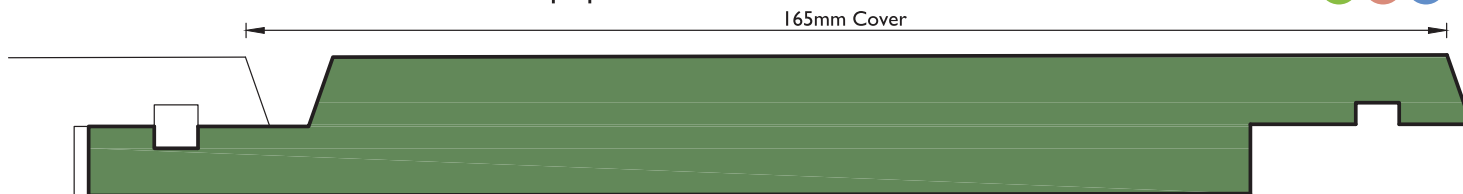

P53 Bevel Grooved Vertical Shiplap Profile

A C R



P54 Bevel Grooved Vertical Shiplap Profile

A C R

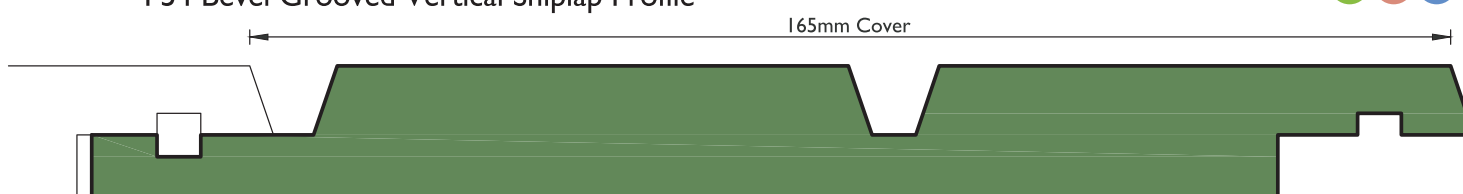

P57 Bevel Grooved Vertical Shiplap Profile

A C R

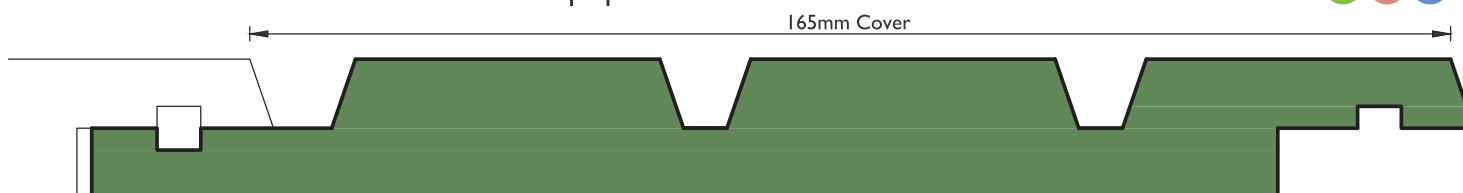

A ACCOYA®
19mm thick

C WESTERN RED CEDAR
18.5mm thick

R RADIATA PINE
19mm thick

Vertical - Shiplap Weatherboards

P55 Square Grooved Vertical Shiplap Profile

A C R

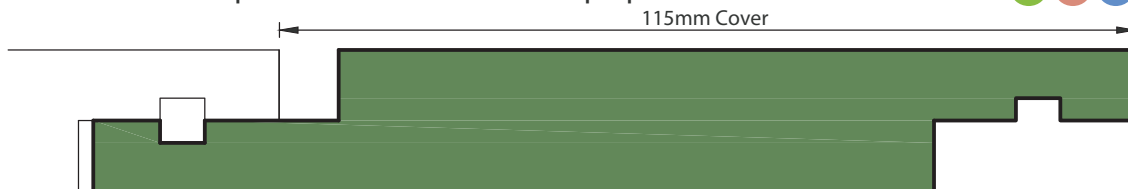

P56 Square Grooved Vertical Shiplap Profile

A C R

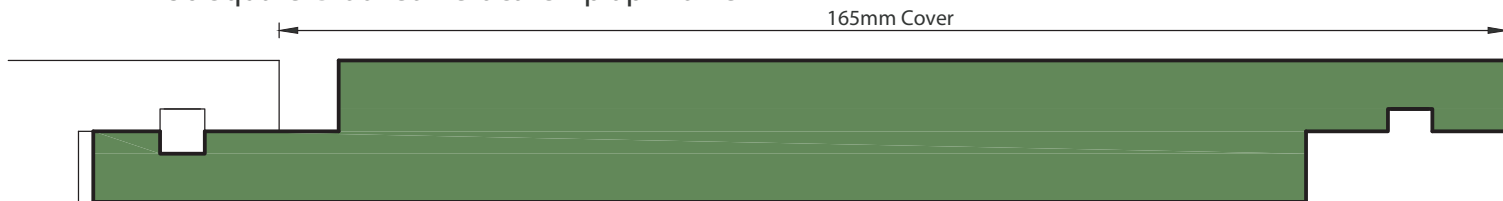

P58 Square Grooved Vertical Shiplap Profile

A C R

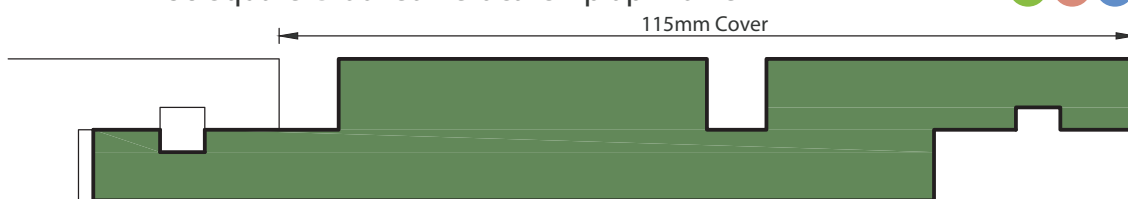

P920 Accoya Vertical Shiplap, 240 wide profile

A

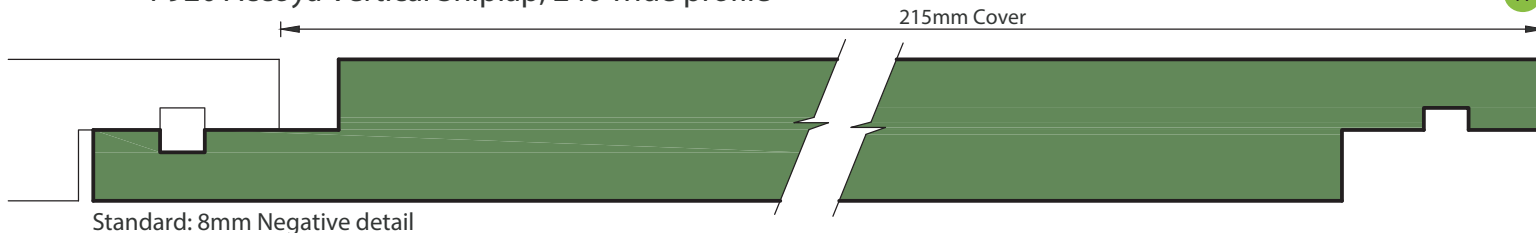

P50 'V' Joint Vertical Shiplap Profile

A C

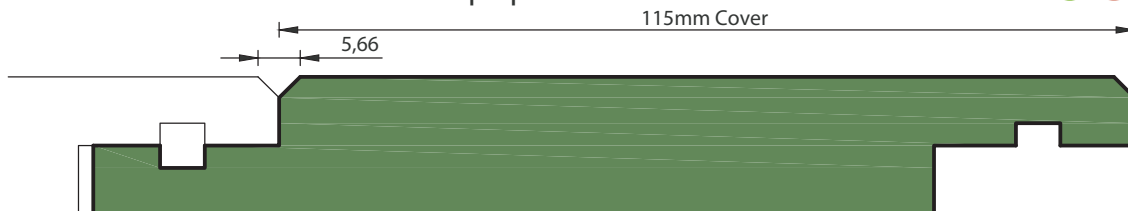

A ACCOYA®
19mm thick

C WESTERN RED CEDAR
18.5mm thick

R RADIATA PINE
19mm thick

Vertical - Shiplap Weatherboards

P59 Square Grooved Vertical Shiplap Profiles

A C R

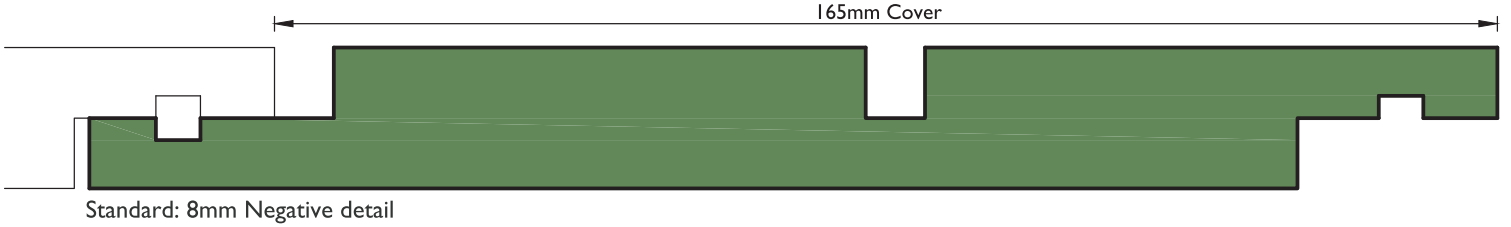

P60 Square Grooved Vertical Shiplap Profiles

A C R

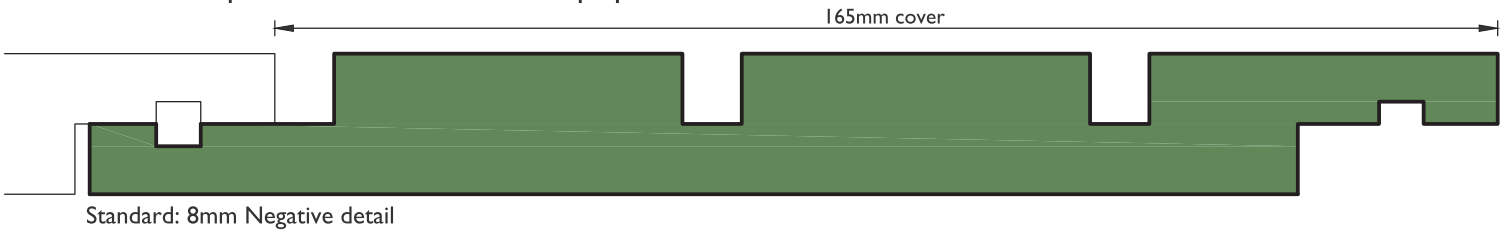

Random Series (Combination Profiles 6mm negative detail)

A C

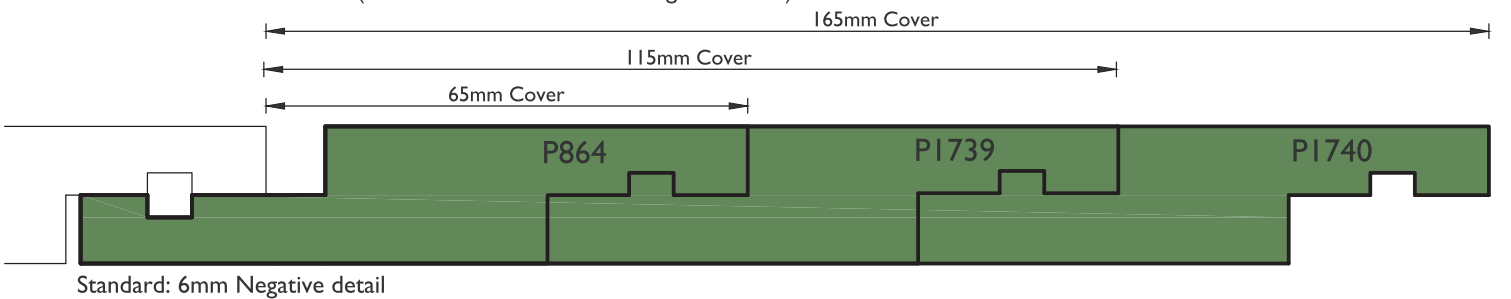

Random Series (Combination Profiles 6mm negative detail)

A C

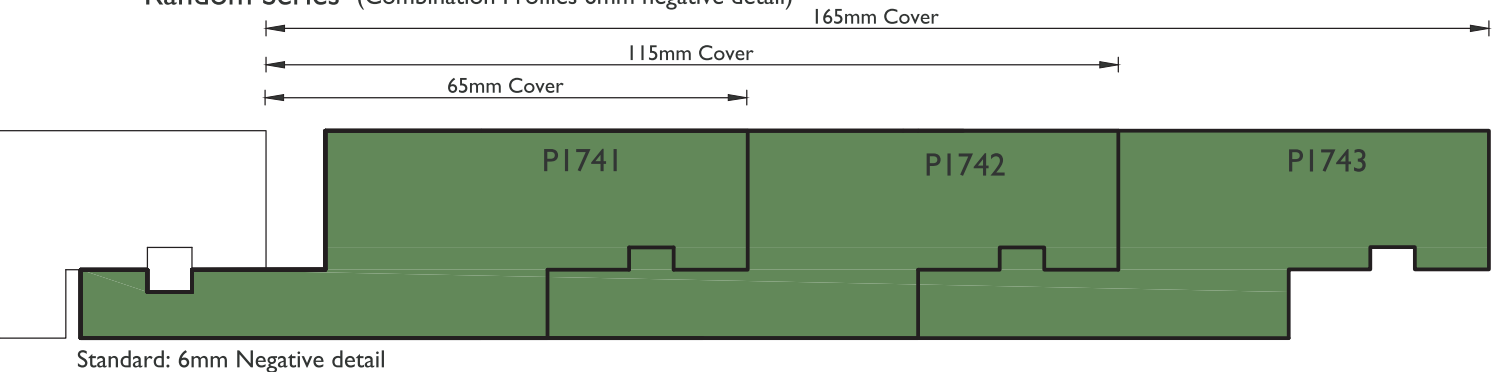

A ACCOYA®
19mm thick

C WESTERN RED CEDAR
18.5mm thick

R RADIATA PINE
19mm thick

Paint and Stain Profile

Vertical Shiplap Profiles

— Paint dry film build

(a) Profile types with sharp corners are not suitable for paint, stain only.

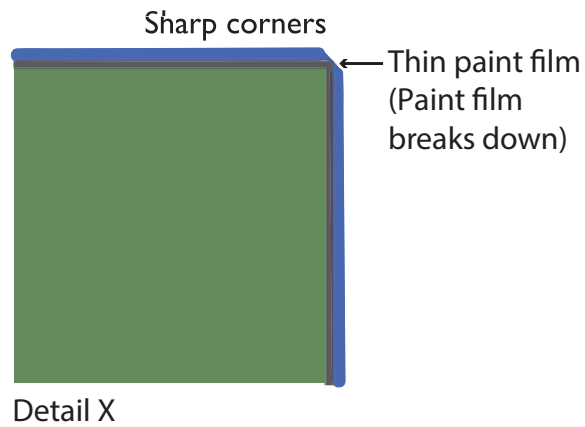
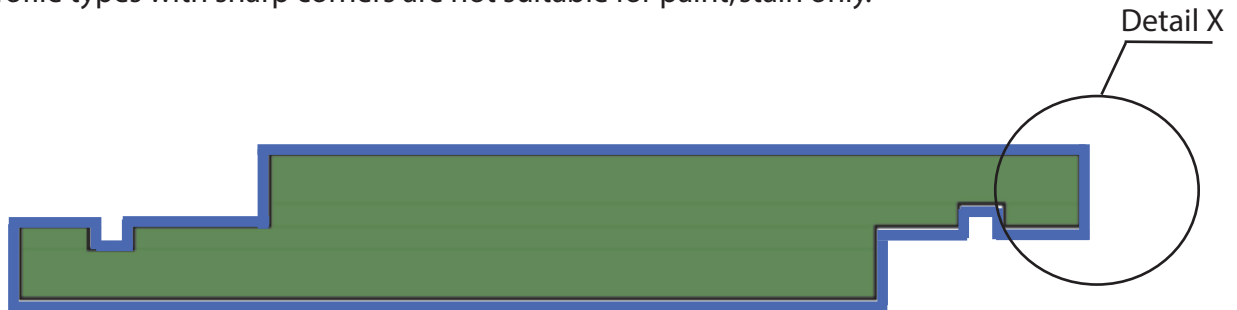

(b) Profile types with radiused corners are suitable for paint or stain.

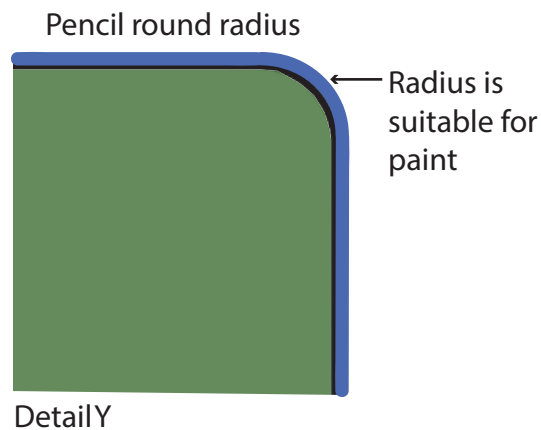
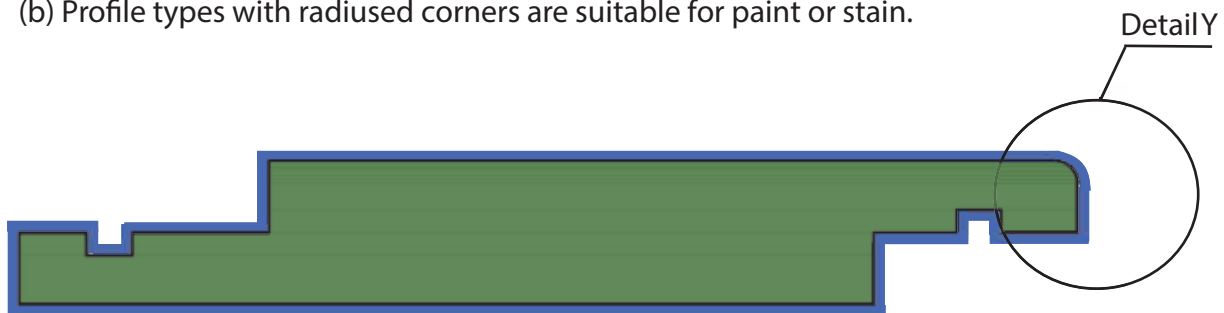

2. Mouldings

Species Available: Accoya/ Radiata Pine /Western Red Cedar.
Other Species available on request.



Mouldings

Cover board

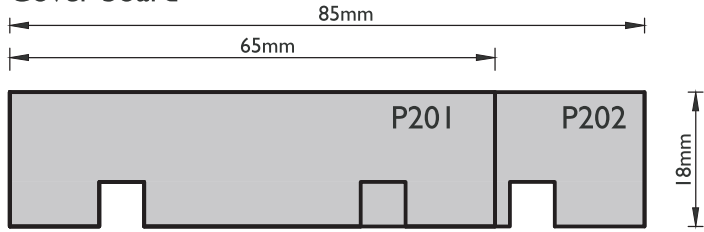

Scriber

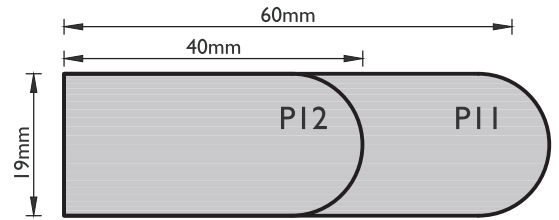

P43 Rustic Plug

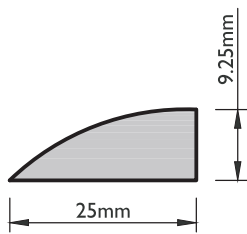

P42 External Corner Moulding

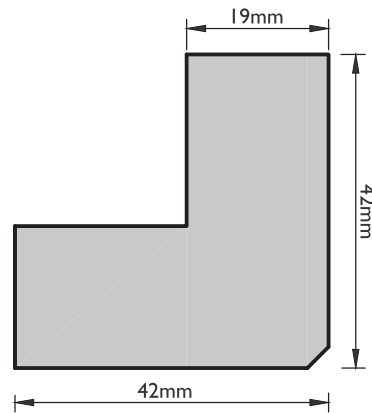

P40 External Corner Moulding

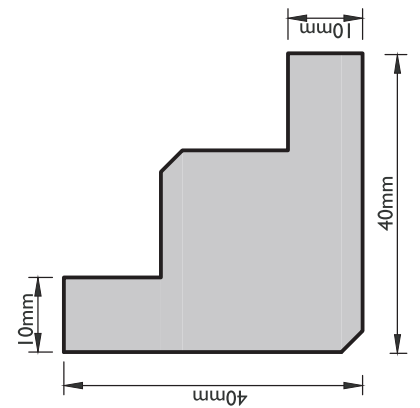

Internal Corner Mouldings

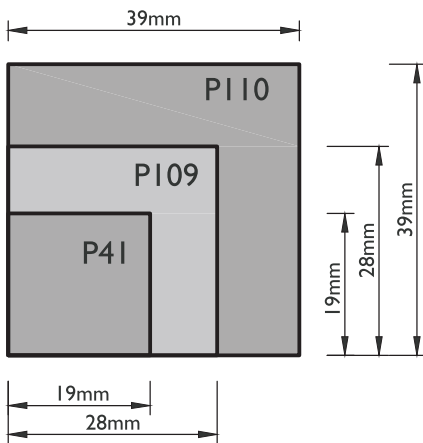

P35I Internal Corner Moulding

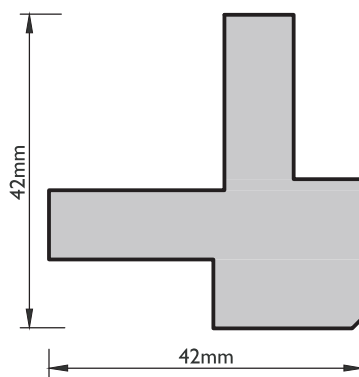

P300 External Corner Moulding

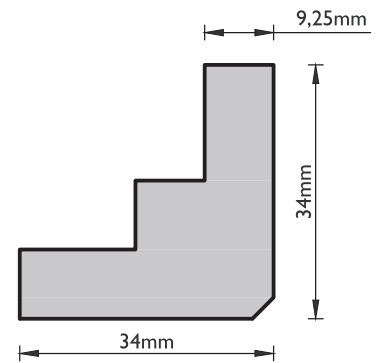

Eaves Moulding

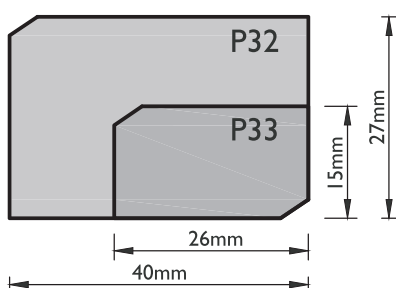

P32I External Corner Moulding

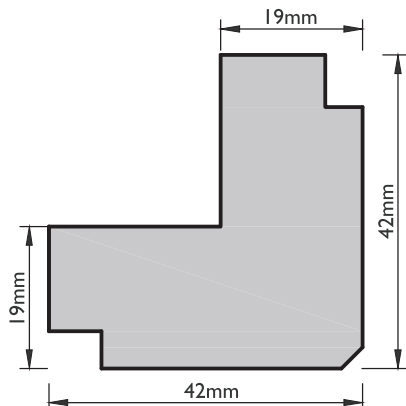

P330 External Corner Moulding

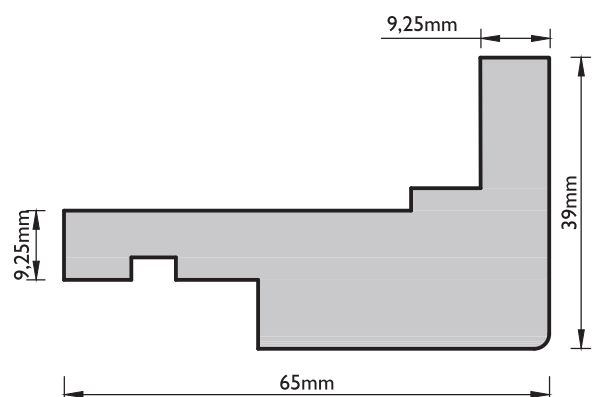

3. Fascia



Fascia

- A** ACCOYA®
19mm or 28mm thick
- C** WESTERN RED CEDAR
18.5mm or 28mm thick
- R** RADIATA PINE
19mm or 28mm thick

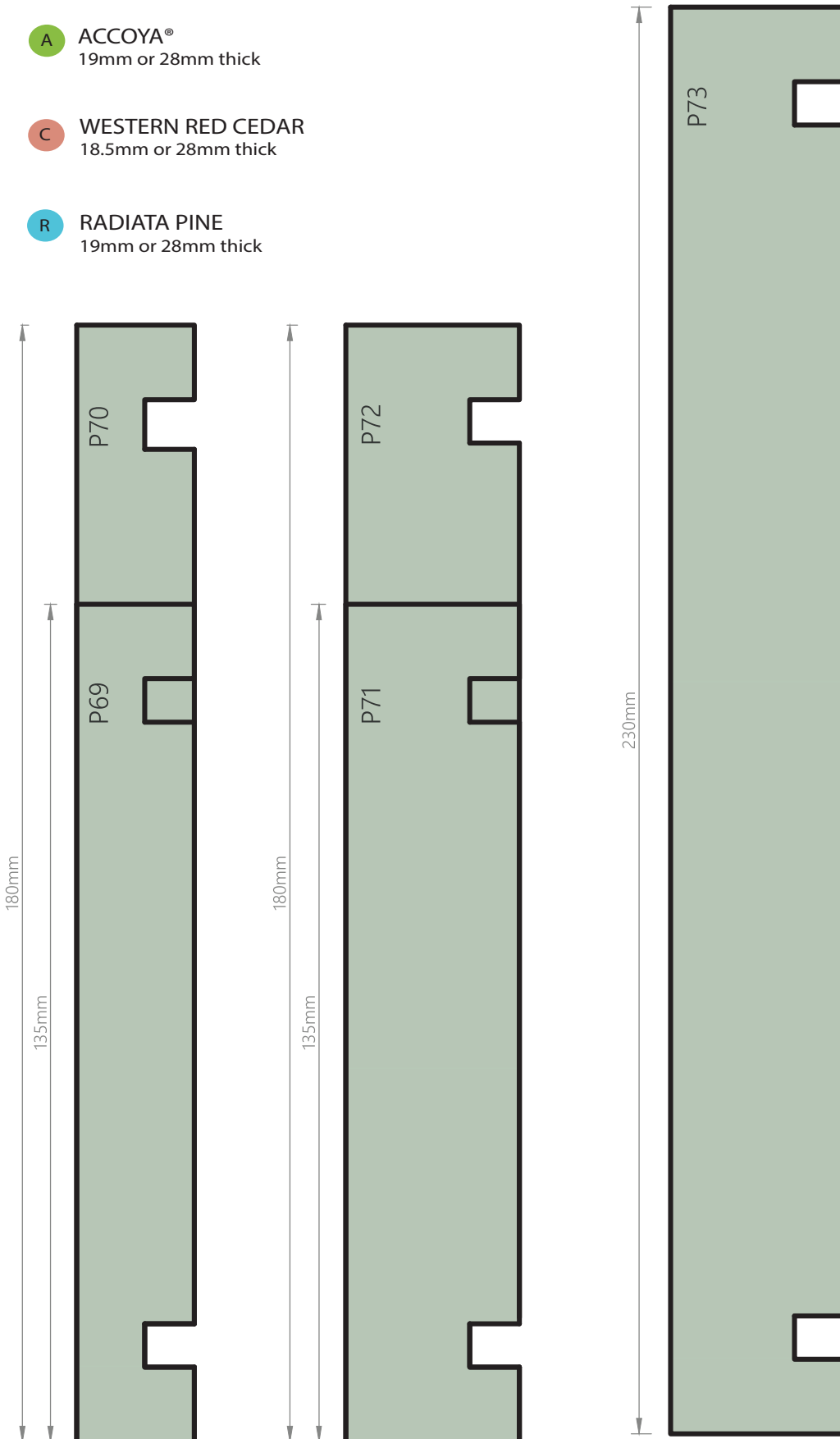

4. Dressed Four Sides (D4S)

Species available: Accoya, Radiata Pine, Western Red Cedar
Other species available on request.



D4S Profiles

- **ACCOYA®**
19mm thick
- **WESTERN RED CEDAR**
18.5mm thick
- **RADIATA PINE**
19mm thick

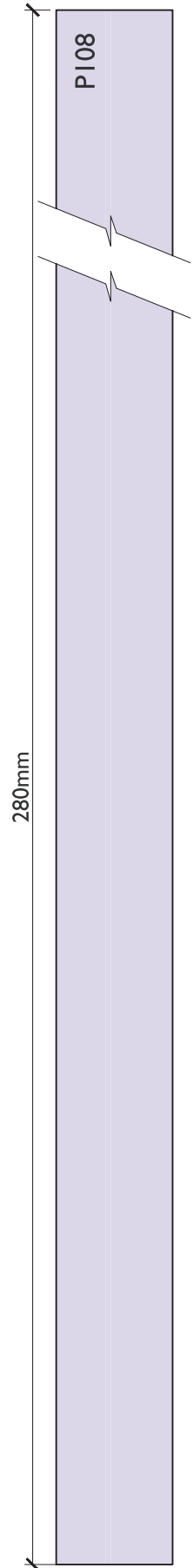
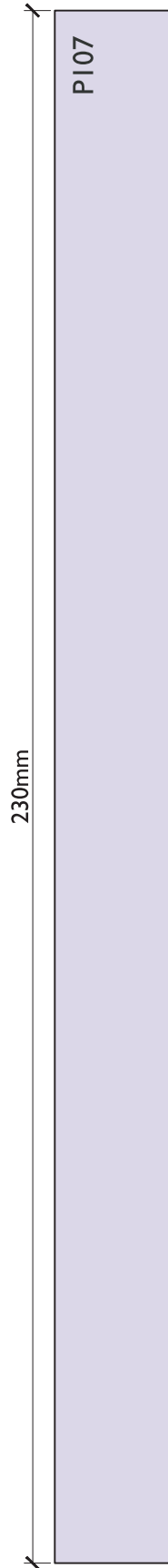
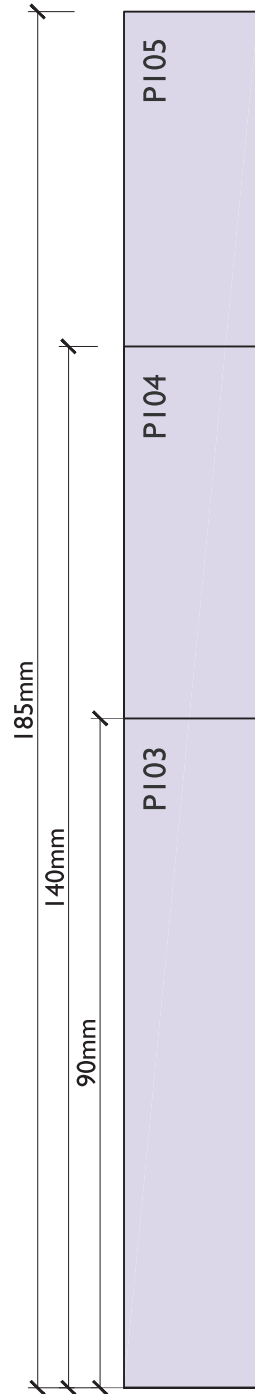
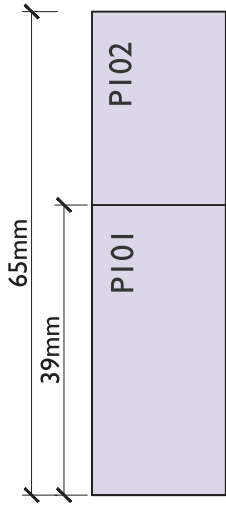

D4S Profiles

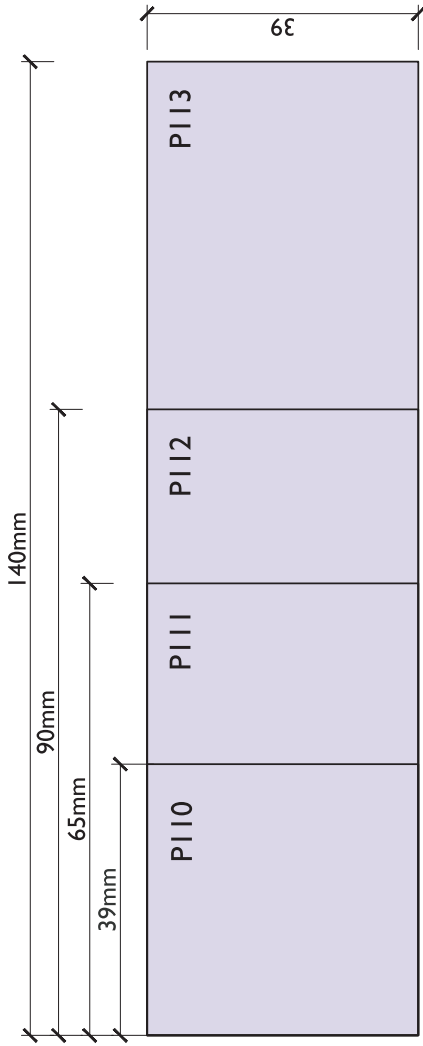

- **A** ACCOYA®
19mm thick
- **C** WESTERN RED CEDAR
18.5mm thick
- **R** RADIATA PINE
19mm thick

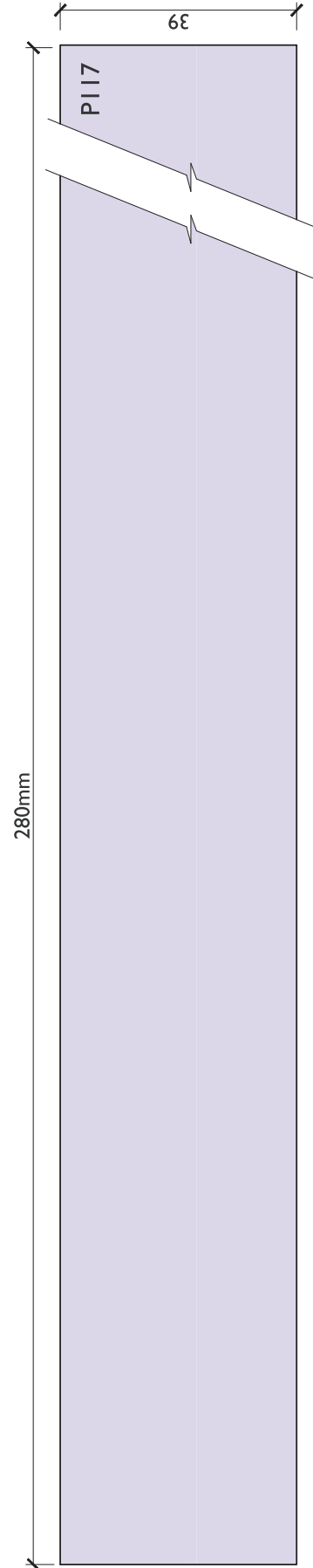
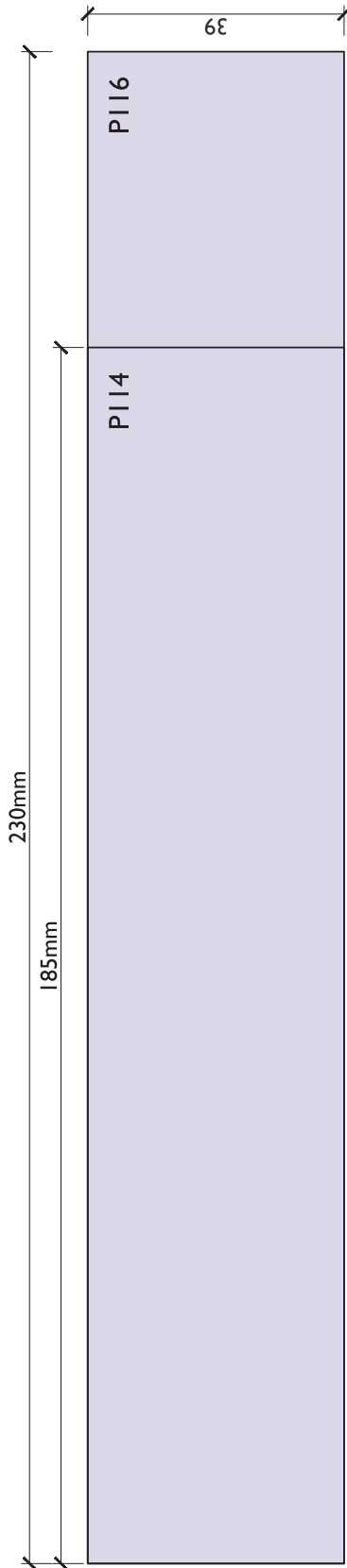

5. Decking

5.1 CertDeck Timber Decking Profiles

5.2 Eva-Last Composite



Timber Decking Profiles

1. Accoya Decking Profiles

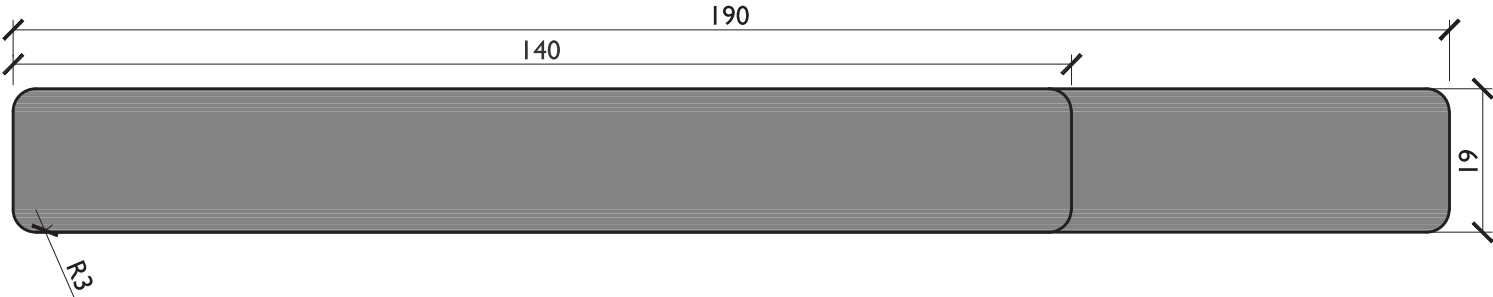

2. Kwila Decking Profiles

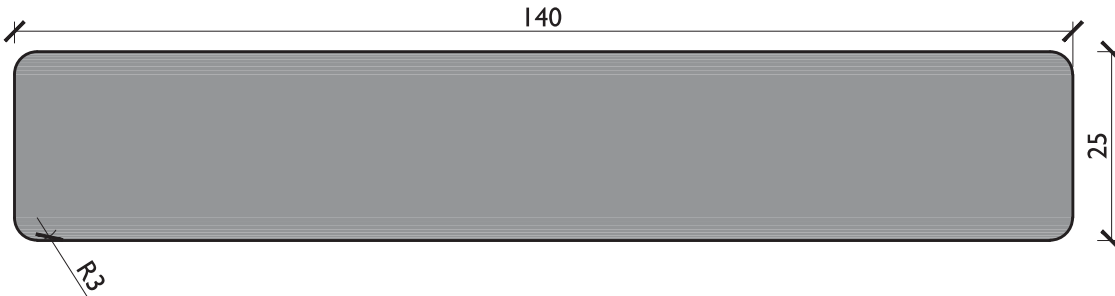
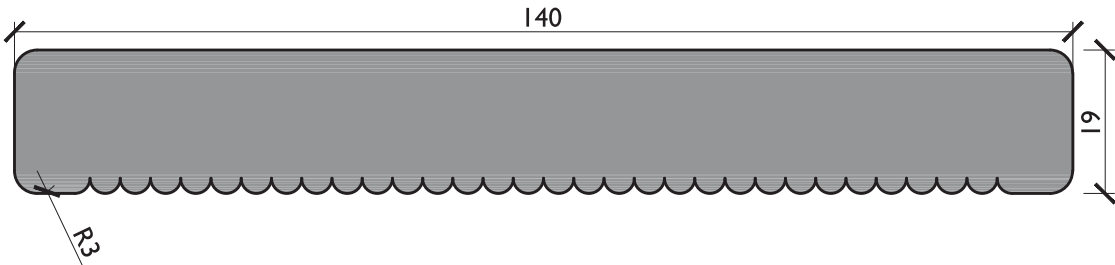
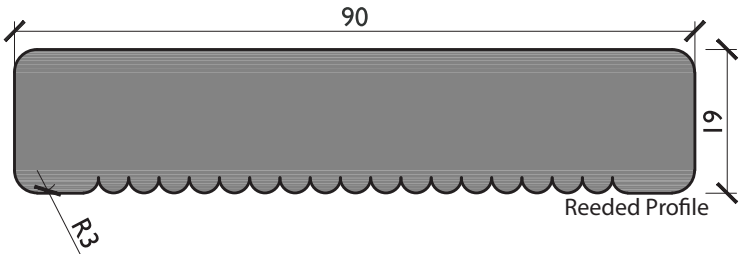

The mark of responsible forestry
Accoya & Kwila are FSC® certified

Timber Decking Profiles

2. Kwila Decking Profiles

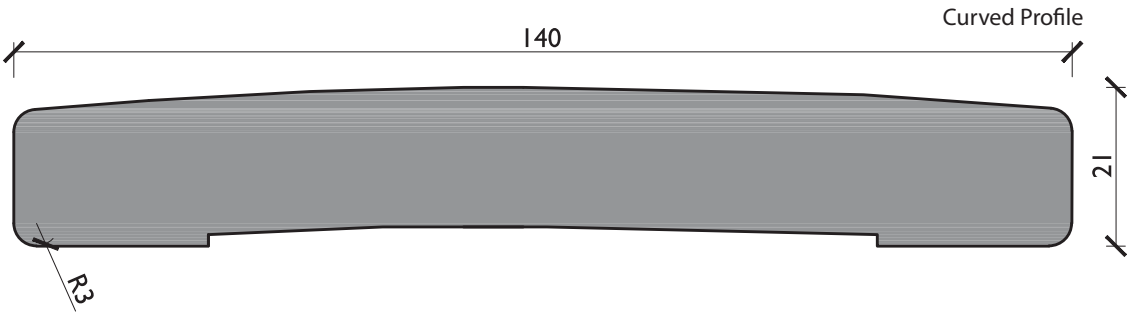
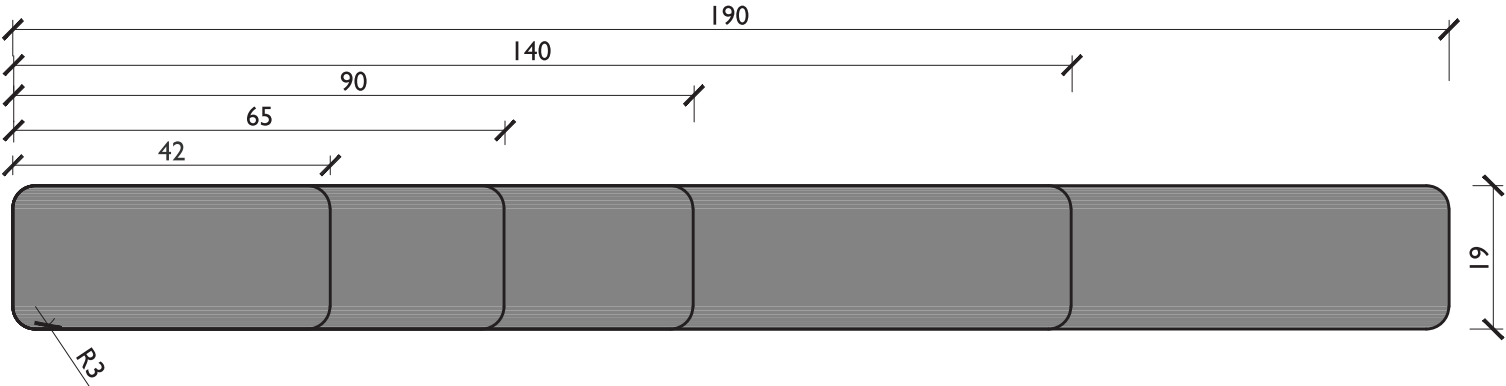

The mark of responsible forestry

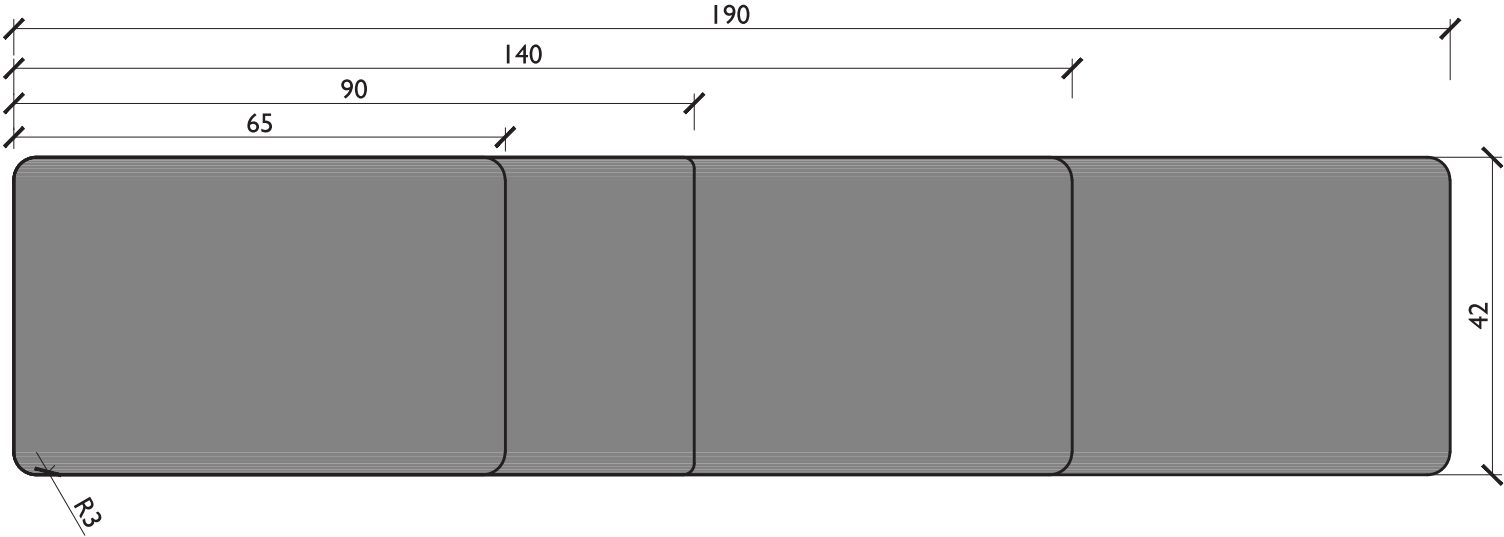
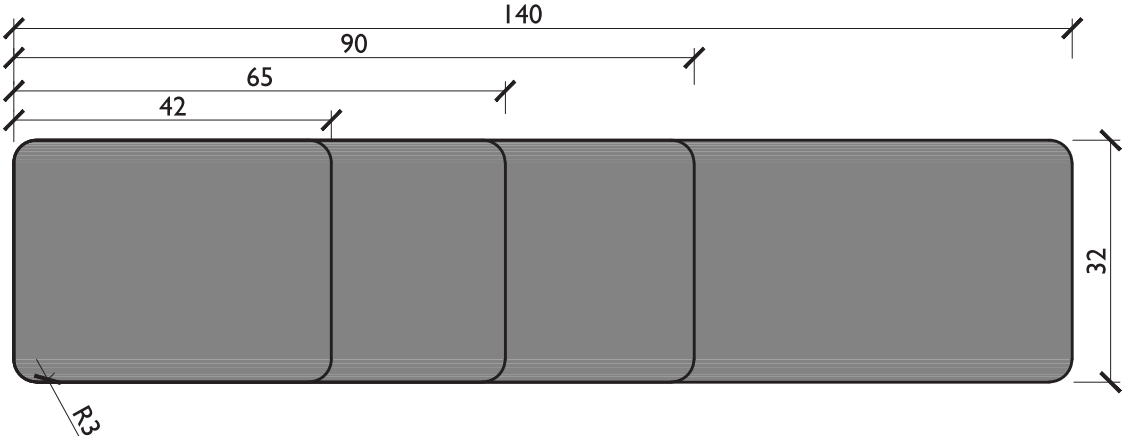

Decking Profiles

3. Spotted Gum Decking Profiles

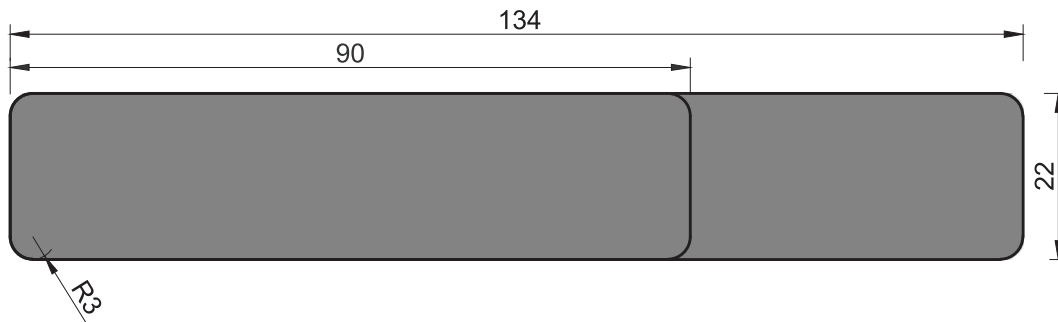

Spotted Gum is PEFC™ certified

4. Vitex Decking Profiles

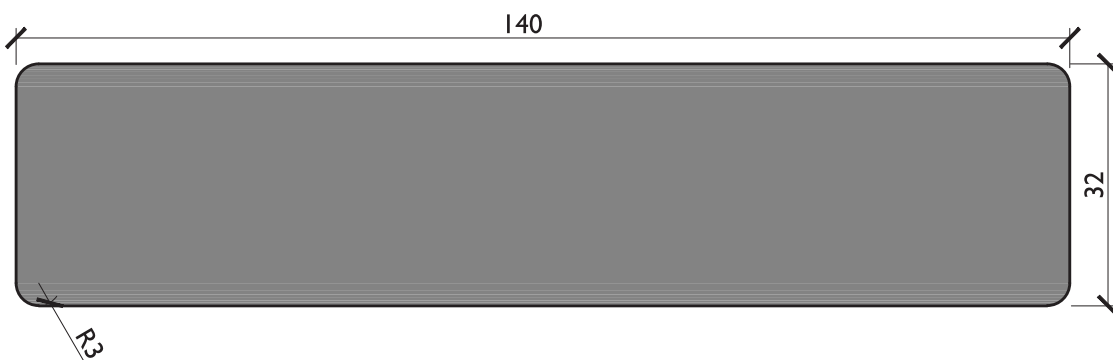
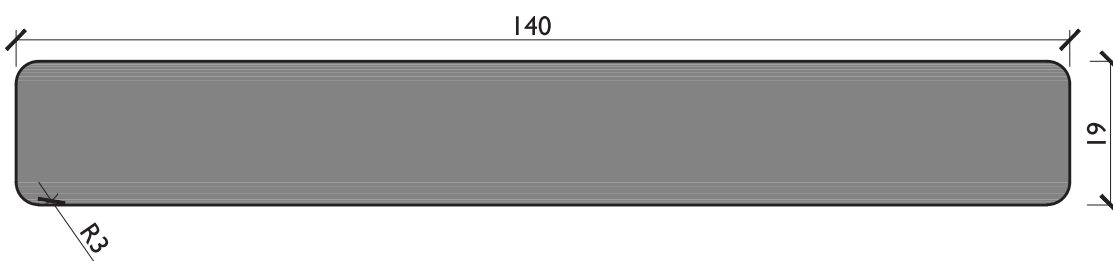
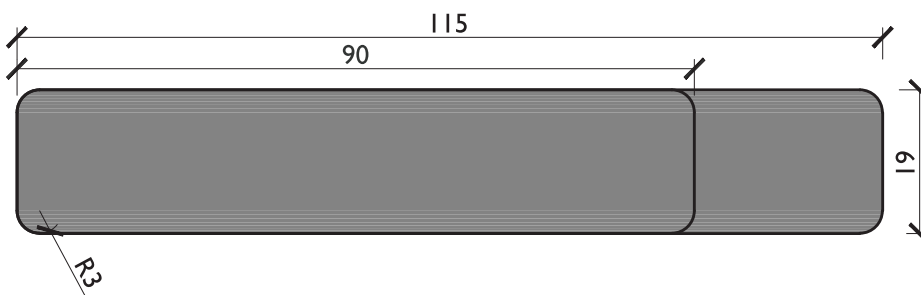

Eva-Last Decking Profiles: I-Series

Bamboo + Recycled plastic Composite

a) Grooved Board



Dimensions: 135mm X 25.4mm, Length 5800mm



18 HULK Clips and screws/m²
(uses HULK S9 Clip)

b) Starter Board



Dimensions: 135mm X 25.4mm, Length 5800mm



9 HULK Clips and 18 CDS screws/m²
(uses HULK S9 Clip)

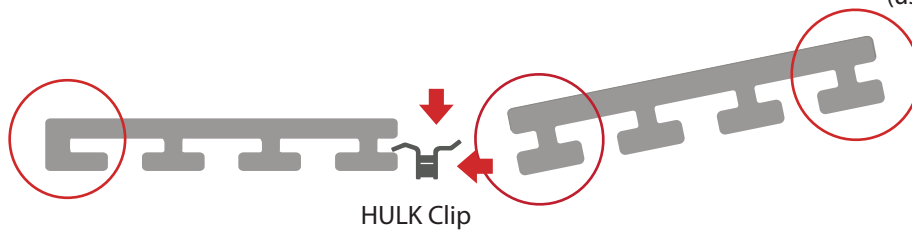

HULK Clip

b) INFINITY Double Sided Fascia Board



Dimensions: 305mm X 18mm, Length 3600mm

Colours available

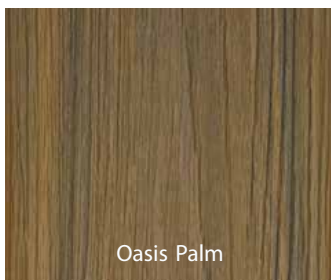

Oasis Palm

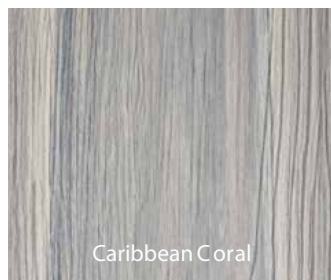

Caribbean Coral



Concrete Grey

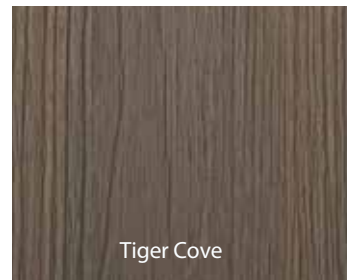

Tiger Cove



6. Interior Mouldings - EziTrimPlus

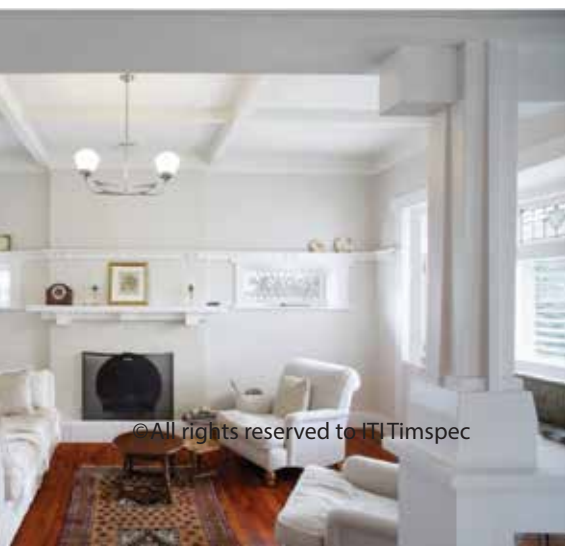

©All rights reserved to ITI Timspec

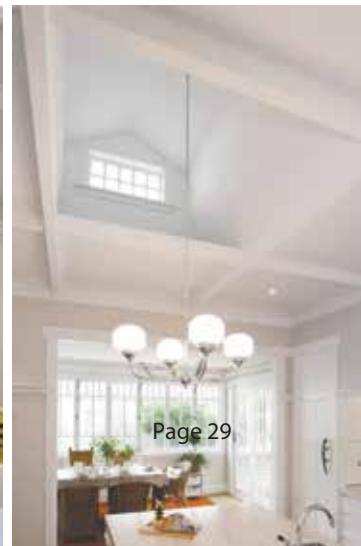

Page 29

Ezi-TrimPlus Mouldings

1. DAR - Dressed All Around

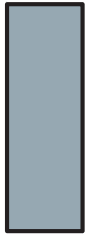

Available sizes	
30X10mm	5.4m
40X10mm	5.4m
60X10mm	5.4m
90X10mm	5.4m
135X10mm	5.4m
18X18m	5.4m
60X18m	5.4m
90X18m	5.4m
135X18mm	5.4m

2. Government

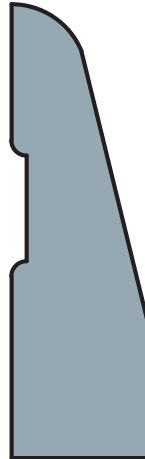

Available sizes	
60X18m	5.4m
90X18m	5.4m
135X18mm	5.4m

3. Single Bevel



Available sizes	
40X10/18mm	5.4m
60X10/18mm	5.4m
90X10/18mm	5.4m

4. Bull Nose

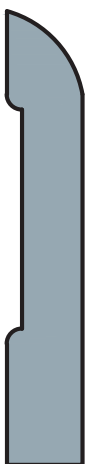

Available sizes	
40X10	5.4m
60X10	5.4m
90X10	5.4m

5. Scotia (35mm)

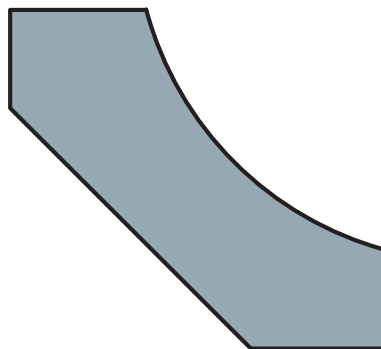

Available sizes	
35X35mm	5.4m

6. Bevelled Cornice

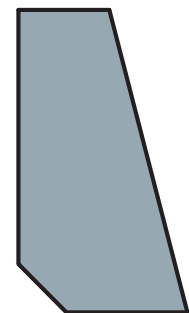

Available sizes	
40X18mm	5.4m

Ezi-TrimPlus Mouldings

7. Two Piece Jambs

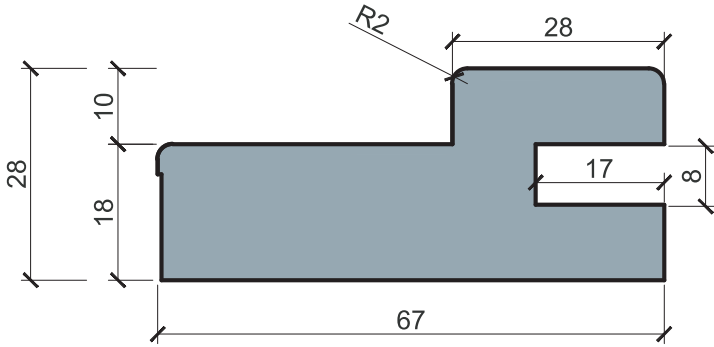

PI339 - 67X28mm

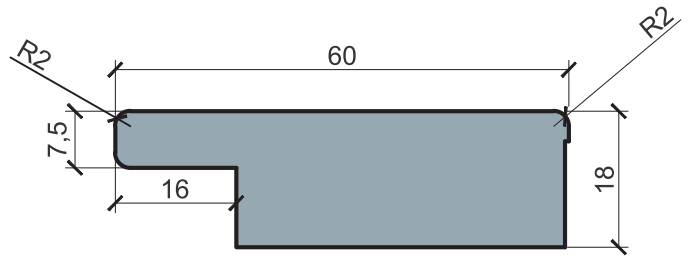

PI340 - 60X18mm

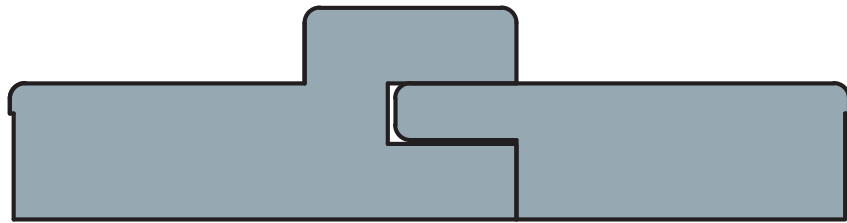

8. Two Piece Jambs

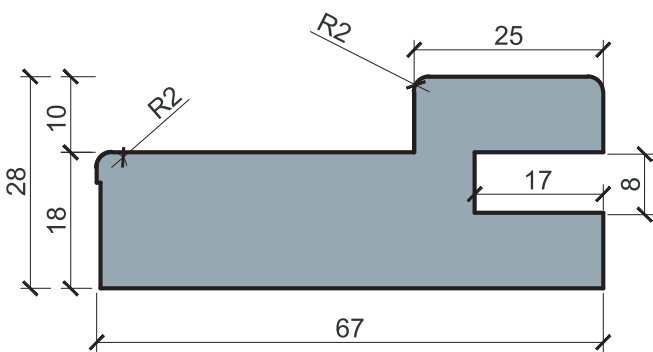

PI342 - 67X28mm

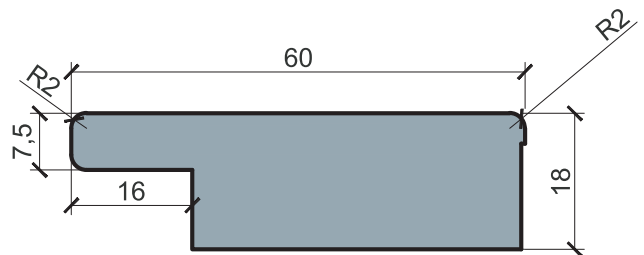

PI340 - 60X18mm

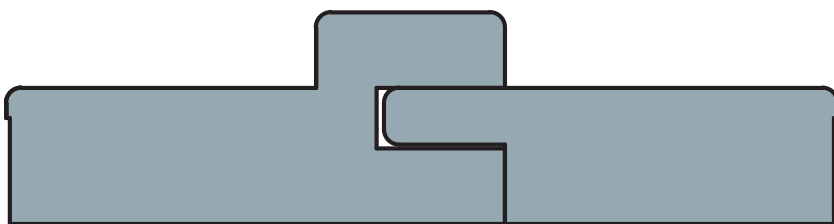

Ezi-TrimPlus Mouldings

9. Door Jambs 112X18mm

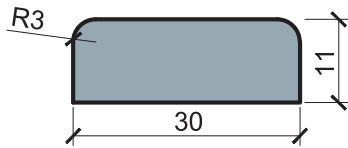

PI360

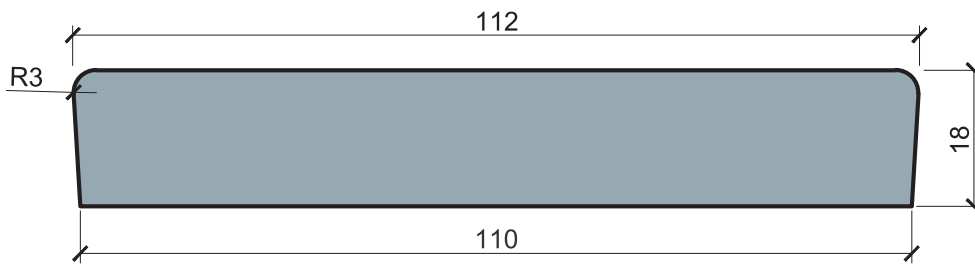

PI361

10. Door Jambs 112X25mm

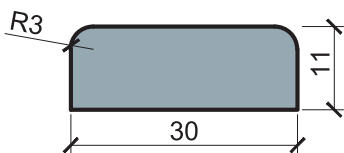

PI362

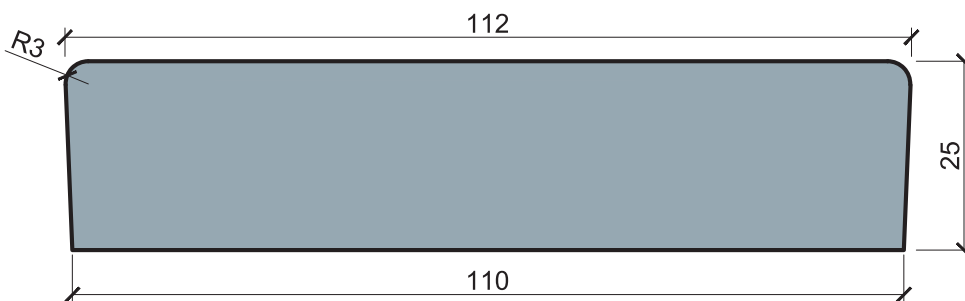

PI363

7. Paneling | Sarking | Soffit Linings



Panelling | Sarking | Soffit Linings

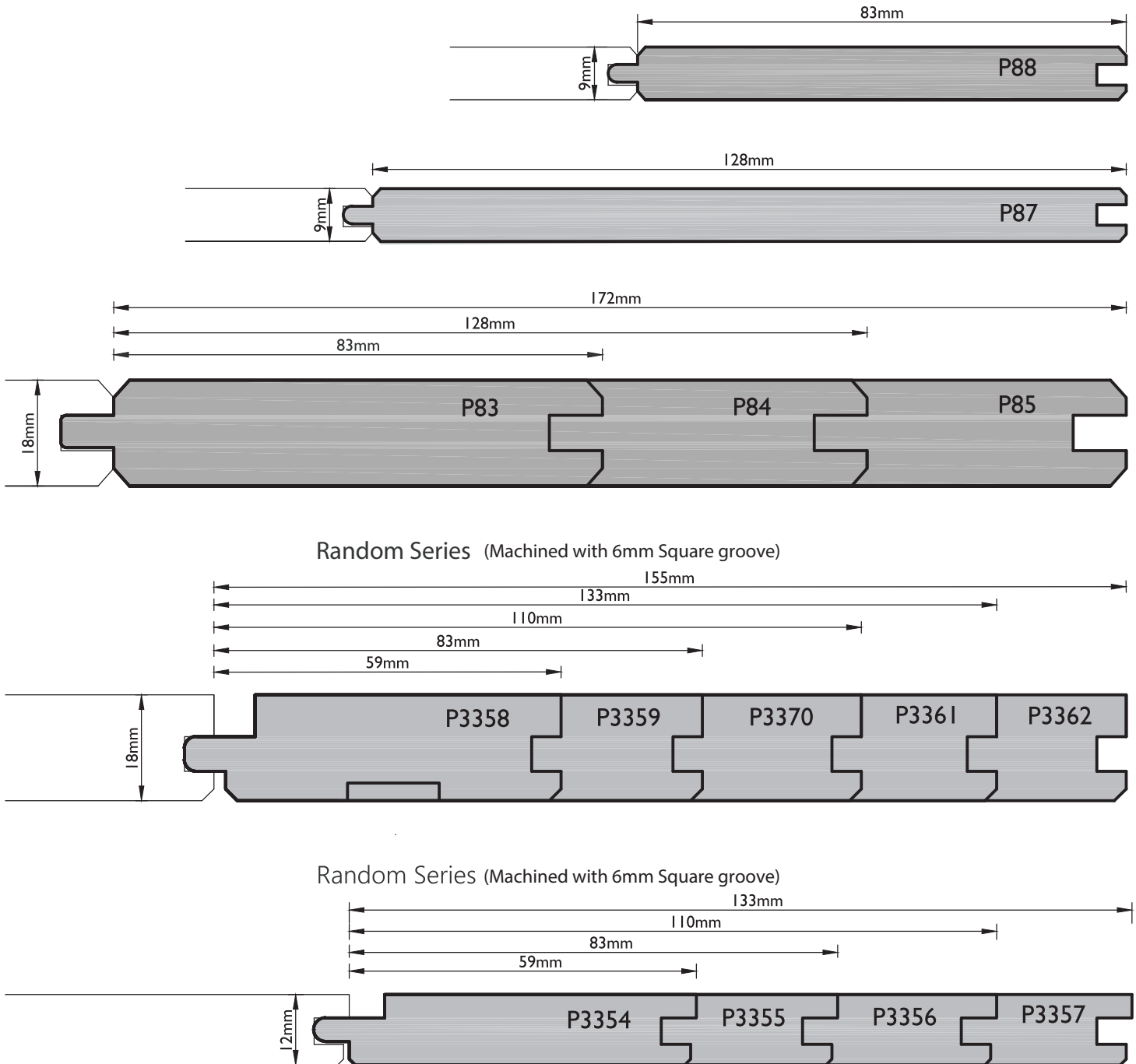

DRAWINGS NOT TO SCALE

8. CertFloor Flooring

8.1 Engineered Flooring - T&G

8.2 Solid Hardwood Flooring - T&G



Engineered T&G Flooring

European Oak Flooring

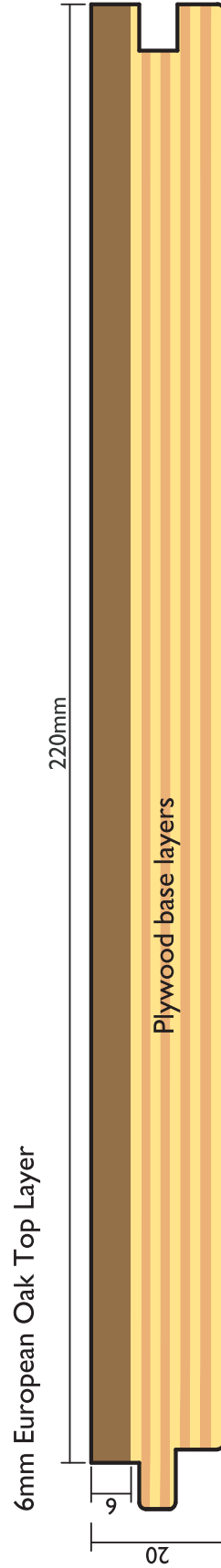
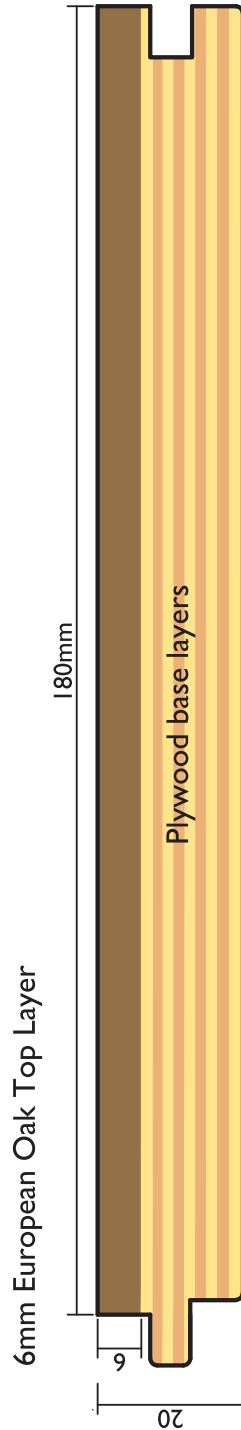
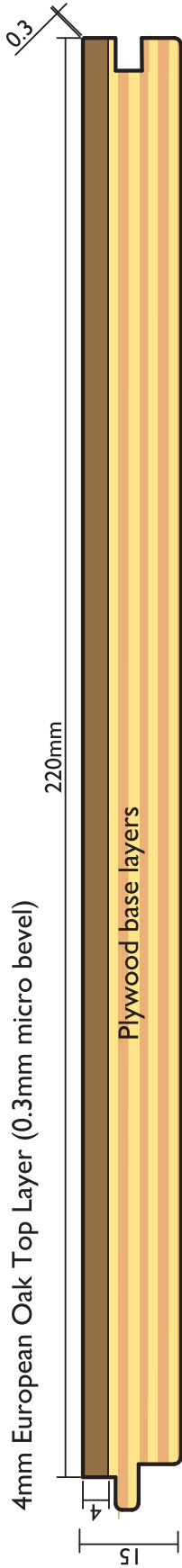
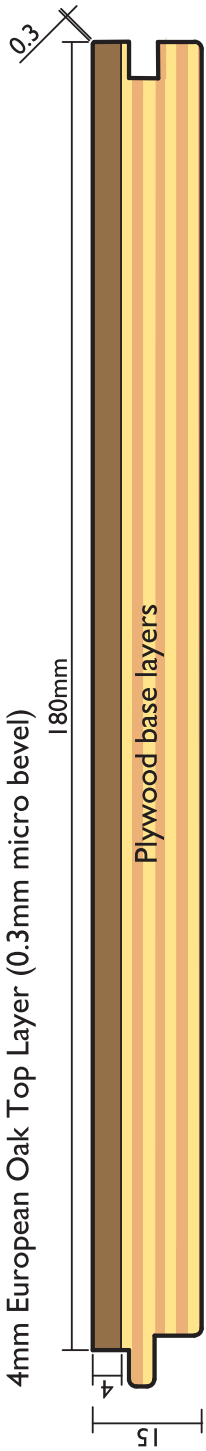

Engineered Flooring

Spotted Gum/ Blackbutt - Engineered Flooring

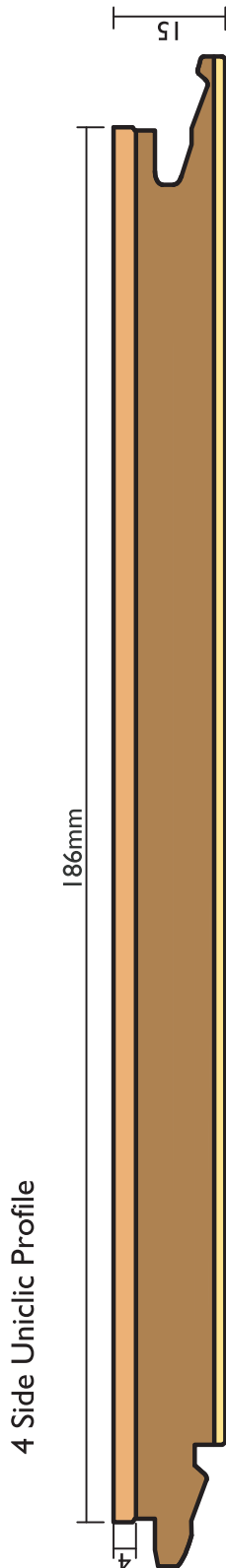

- No mess and fumes from sanding and finishing.
- Boral® Engineered Flooring can be walked on within hours of installation.
- Boral® Engineered Flooring can be glued or 'floated' over a level sub-floor such as a concrete slab, particle board or plywood sheeting or over old timber floors or tiles. For further information, please visit www.ititimspec.nz/Downloads/6733/
- A variety of quality underlays can be installed with Boral® Engineered Flooring to provide a range of flooring solutions such as floor leveling, cushioning and acoustic properties.
- Boral® Engineered Flooring 134mm is pre-finished with seven layers of matte finish 35% gloss UV cured acrylic coating, while the 186mm is coated with a 10% UV cured acrylic matte and brushed for added texture.
- The 4mm nominal hardwood top layer allows re-sanding and re-coating for a long service life.
- The board has a precision-milled square edge and a 4 side Uniclic profile for a tight board-to-board fit and a smooth consistent finish.
- The product range is available in three beautiful Australian hardwood species.
- The clear coating highlights the natural colour and timber features.



Solid T&G Flooring

P8811 83X19mm Flooring



P8812 133X19mm Flooring

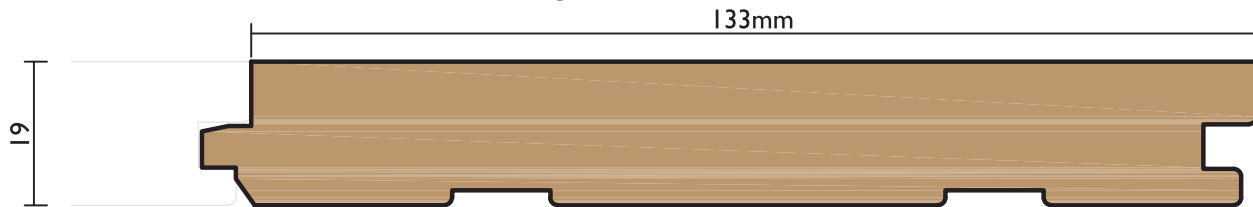

P8813 85X12mm Flooring



P8814 85X19mm Flooring

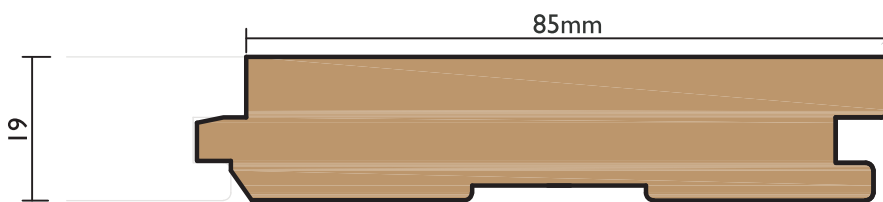

Solid T&G Flooring

P8815 128X19mm Flooring

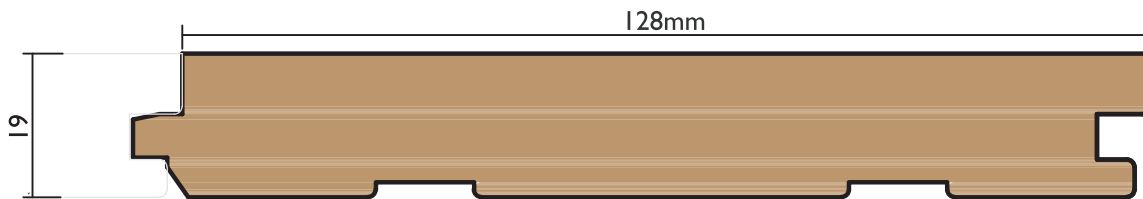

P8816 130X19mm Flooring

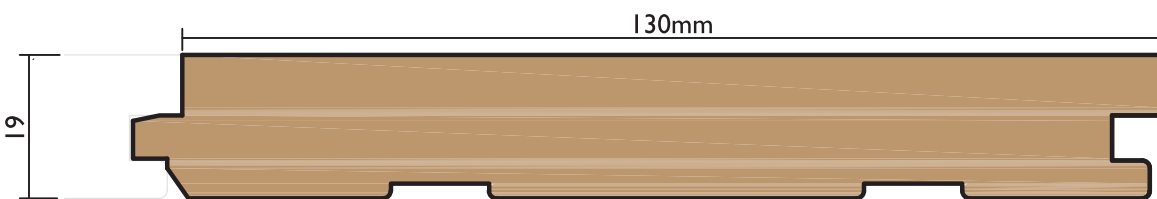

P8817 162X19mm Flooring

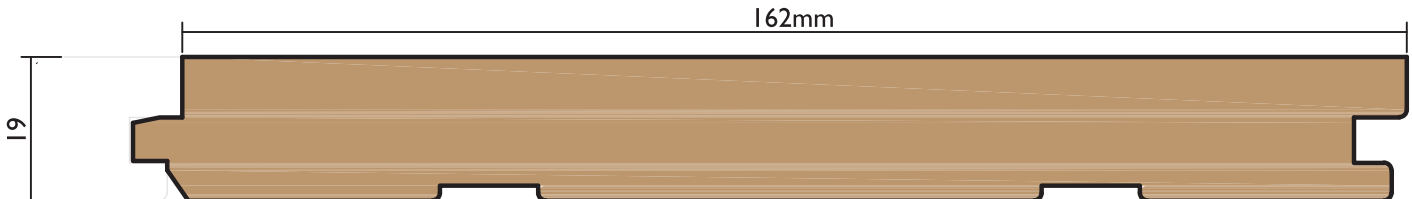

T&G Solid hardwood Flooring Species

American hard Maple | American Red Oak | American White Oak | American White Ash | Australian Blackwood | Australian Oak | Pilularis Blackbutt | Black Walnut | European White Oak | Jarrah | Kwila | Roasted White Ash (American) | Roasted White Oak (American) | Rosewood | Spotted Gum | Taun/Akwa

For more information, please visit www.ititimspec.nz

Solid T&G Flooring

P8818 172X19mm Flooring

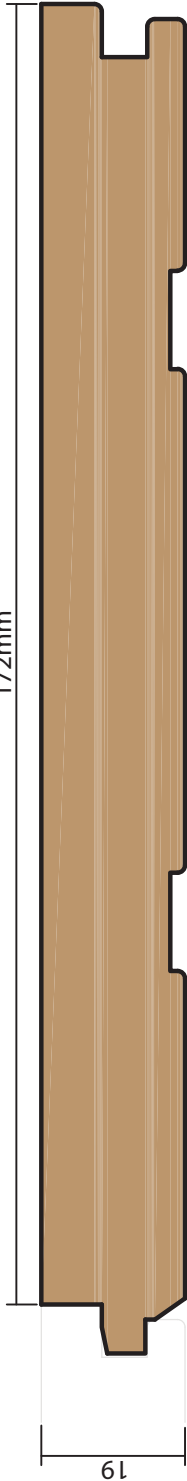

P8821 205X19mm Flooring

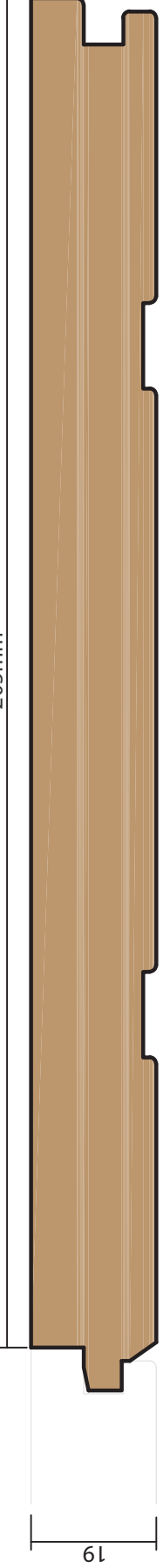

P3396 98X19mm Flooring

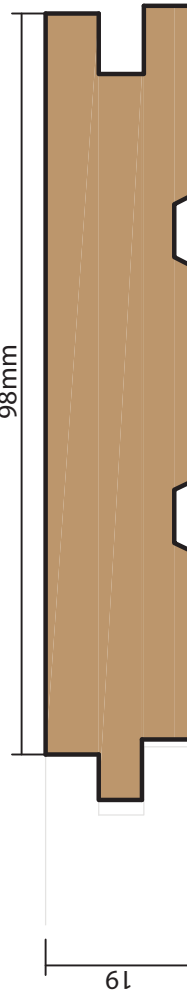

Verandah profile, available only in Accoya®
(Contact ITI Timspec for more sizes)



www.ititimspec.nz

0800 ITI NZL

sales@ititimspec.co.nz

Auckland

64 C Stoddard Road, Mt Roskill 1041

Christchurch

14 Braeburn Drive, Hornby 8042